

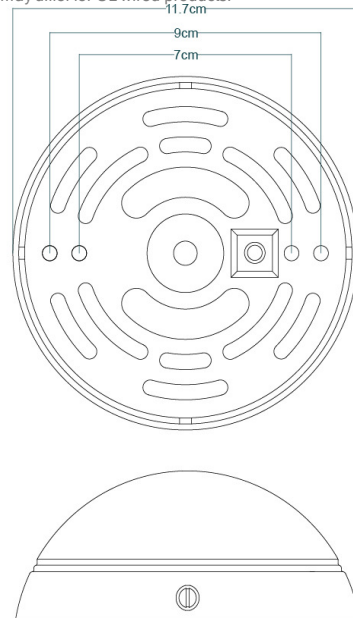

MATERIAL	Brass Ceramic Glass
HEIGHT	n/a
WIDTH DIAMETER	21cm 8.27"
LENGTH PROJECTION	13cm 5.12"
WEIGHT	0.7KG 1.54lbs
LAMP HOLDER	G9
MAX WATTAGE	5W x 1
VOLTAGE	220/240v or 110/120v*
IP RATING	20
CLASS PROTECTION	I
SHADE CODE	GL192 MLCS062
CABLE CHAIN BAR LENGT	n/a
CABLE TYPE	-

Fixing Bracket MLWB11

* Fixing bracket may differ for UL wired products.



Product Notes:

1) Bulbs not included. 2) Dimensions do not include bulbs. 3) All products are individually made-to-order and therefore may differ slightly within manufacturing tolerances. 4) Cable / chain can be shortened during installation. Longer cable / chain lengths available on request. 5) Additional colour finishes may be available on request. 6) UL wired products operate at 110/120v with the appropriate lamp holder. 7) Twisted cable is not available for UL wired products. Round cable in black or brown only is supplied instead. 8) Refer to our website for a full list of terms and conditions.



MATERIAL	Brass Ceramic Glass
HEIGHT	n/a
WIDTH DIAMETER	21cm 8.27"
LENGTH PROJECTION	13cm 5.12"
WEIGHT	0.7KG 1.54lbs
LAMP HOLDER	G9
MAX WATTAGE	5W x 1
VOLTAGE	220/240v or 110/120v*
IP RATING	20
CLASS PROTECTION	I
SHADE CODE	GL196 MLCS062
CABLE CHAIN BAR LENGT	n/a
CABLE TYPE	-

Fixing Bracket MLWB11

* Fixing bracket may differ for UL wired products.

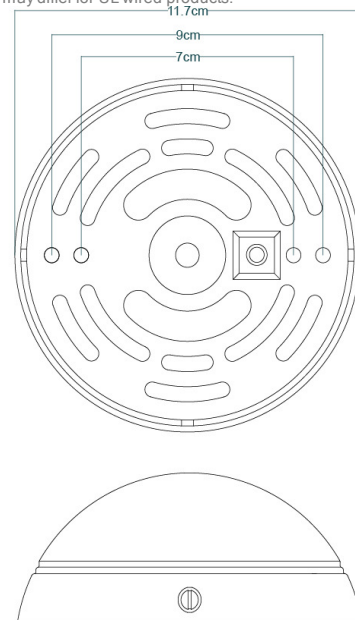

Product Notes:

1) Bulbs not included. 2) Dimensions do not include bulbs. 3) All products are individually made-to-order and therefore may differ slightly within manufacturing tolerances. 4) Cable / chain can be shortened during installation. Longer cable / chain lengths available on request. 5) Additional colour finishes may be available on request. 6) UL wired products operate at 110/120v with the appropriate lamp holder. 7) Twisted cable is not available for UL wired products. Round cable in black or brown only is supplied instead. 8) Refer to our website for a full list of terms and conditions.



MATERIAL	Brass Ceramic Glass
HEIGHT	n/a
WIDTH DIAMETER	21cm 8.27"
LENGTH PROJECTION	13cm 5.12"
WEIGHT	0.7KG 1.54lbs
LAMP HOLDER	G9
MAX WATTAGE	5W x 1
VOLTAGE	220/240v or 110/120v*
IP RATING	20
CLASS PROTECTION	I
SHADE CODE	GL208 MLCS062
CABLE CHAIN BAR LENGT	n/a
CABLE TYPE	-

Fixing Bracket MLWB11

* Fixing bracket may differ for UL wired products.

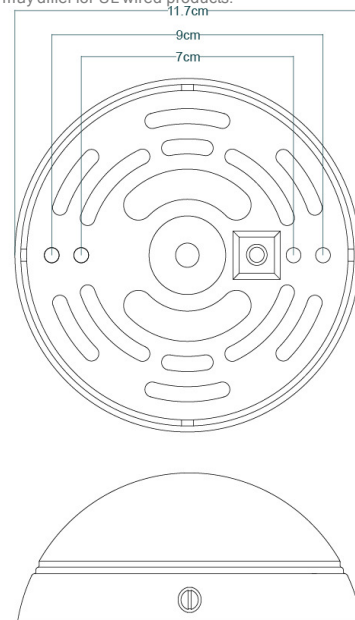

Product Notes:

1) Bulbs not included. 2) Dimensions do not include bulbs. 3) All products are individually made-to-order and therefore may differ slightly within manufacturing tolerances. 4) Cable / chain can be shortened during installation. Longer cable / chain lengths available on request. 5) Additional colour finishes may be available on request. 6) UL wired products operate at 110/120v with the appropriate lamp holder. 7) Twisted cable is not available for UL wired products. Round cable in black or brown only is supplied instead. 8) Refer to our website for a full list of terms and conditions.



MATERIAL	Brass Ceramic Glass
HEIGHT	n/a
WIDTH DIAMETER	21cm 8.27"
LENGTH PROJECTION	13cm 5.12"
WEIGHT	0.7KG 1.54lbs
LAMP HOLDER	G9
MAX WATTAGE	5W x 1
VOLTAGE	220/240v or 110/120v*
IP RATING	20
CLASS PROTECTION	I
SHADE CODE	GL192 MLCS062
CABLE CHAIN BAR LENGT	n/a
CABLE TYPE	-

Fixing Bracket MLWB11

* Fixing bracket may differ for UL wired products.

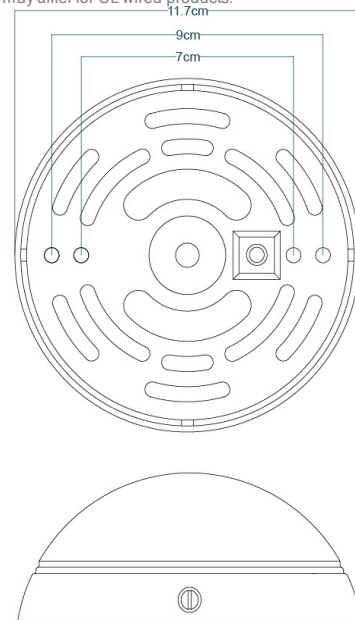

Product Notes:

1) Bulbs not included. 2) Dimensions do not include bulbs. 3) All products are individually made-to-order and therefore may differ slightly within manufacturing tolerances. 4) Cable / chain can be shortened during installation. Longer cable / chain lengths available on request. 5) Additional colour finishes may be available on request. 6) UL wired products operate at 110/120v with the appropriate lamp holder. 7) Twisted cable is not available for UL wired products. Round cable in black or brown only is supplied instead. 8) Refer to our website for a full list of terms and conditions.



MATERIAL	Brass Ceramic Glass
HEIGHT	n/a
WIDTH DIAMETER	21cm 8.27"
LENGTH PROJECTION	13cm 5.12"
WEIGHT	0.7KG 1.54lbs
LAMP HOLDER	G9
MAX WATTAGE	5W x 1
VOLTAGE	220/240v or 110/120v*
IP RATING	20
CLASS PROTECTION	I
SHADE CODE	GL196 MLCS062
CABLE CHAIN BAR LENGT	n/a
CABLE TYPE	-

Fixing Bracket MLWB11

* Fixing bracket may differ for UL wired products.

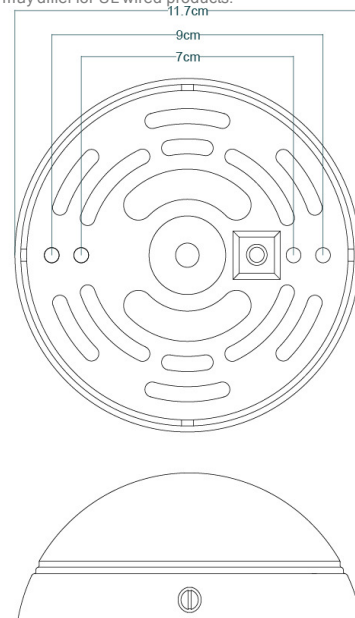

Product Notes:

1) Bulbs not included. 2) Dimensions do not include bulbs. 3) All products are individually made-to-order and therefore may differ slightly within manufacturing tolerances. 4) Cable / chain can be shortened during installation. Longer cable / chain lengths available on request. 5) Additional colour finishes may be available on request. 6) UL wired products operate at 110/120v with the appropriate lamp holder. 7) Twisted cable is not available for UL wired products. Round cable in black or brown only is supplied instead. 8) Refer to our website for a full list of terms and conditions.



RIVALE Ceramic Ceiling Fitting

MLCMCF022ANTSLVFR

Antique Silver



MATERIAL Brass | Ceramic | Glass

HEIGHT n/a

WIDTH | DIAMETER 21cm | 8.27"

LENGTH | PROJECTION 13cm | 5.12"

WEIGHT 0.7KG | 1.54lbs

LAMP HOLDER G9

MAX WATTAGE 5W x 1

VOLTAGE 220/240v or 110/120v*

IP RATING 20

CLASS PROTECTION I

SHADE CODE GL208 | MLCS062

CABLE | CHAIN | BAR LENGT n/a

CABLE TYPE -

Fixing Bracket MLWB11

* Fixing bracket may differ for UL wired products.

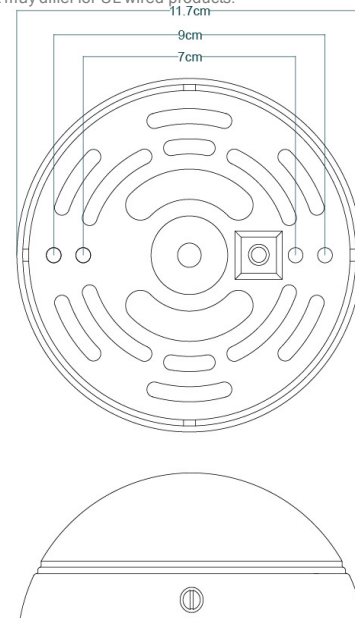

www.mullanlighting.com

Product Notes:

1) Bulbs not included. 2) Dimensions do not include bulbs. 3) All products are individually made-to-order and therefore may differ slightly within manufacturing tolerances. 4) Cable / chain can be shortened during installation. Longer cable / chain lengths available on request. 5) Additional colour finishes may be available on request. 6) UL wired products operate at 110/120v with the appropriate lamp holder. 7) Twisted cable is not available for UL wired products. Round cable in black or brown only is supplied instead. 8) Refer to our website for a full list of terms and conditions.





MATERIAL	Brass Ceramic Glass
HEIGHT	n/a
WIDTH DIAMETER	21cm 8.27"
LENGTH PROJECTION	13cm 5.12"
WEIGHT	0.7KG 1.54lbs
LAMP HOLDER	G9
MAX WATTAGE	5W x 1
VOLTAGE	220/240v or 110/120v*
IP RATING	20
CLASS PROTECTION	I
SHADE CODE	GL192 MLCS062
CABLE CHAIN BAR LENGT	n/a
CABLE TYPE	-

Fixing Bracket MLWB11

* Fixing bracket may differ for UL wired products.

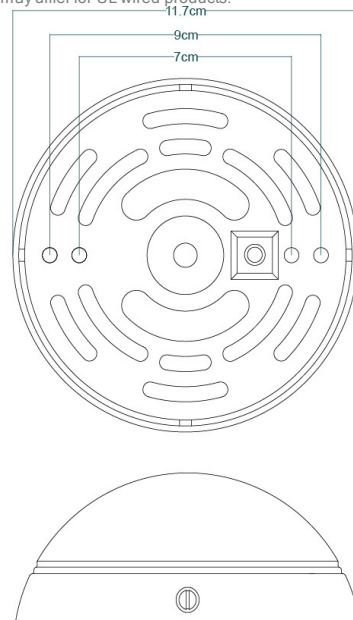

Product Notes:

1) Bulbs not included. 2) Dimensions do not include bulbs. 3) All products are individually made-to-order and therefore may differ slightly within manufacturing tolerances. 4) Cable / chain can be shortened during installation. Longer cable / chain lengths available on request. 5) Additional colour finishes may be available on request. 6) UL wired products operate at 110/120v with the appropriate lamp holder. 7) Twisted cable is not available for UL wired products. Round cable in black or brown only is supplied instead. 8) Refer to our website for a full list of terms and conditions.



MATERIAL	Brass Ceramic Glass
HEIGHT	n/a
WIDTH DIAMETER	21cm 8.27"
LENGTH PROJECTION	13cm 5.12"
WEIGHT	0.7KG 1.54lbs
LAMP HOLDER	G9
MAX WATTAGE	5W x 1
VOLTAGE	220/240v or 110/120v*
IP RATING	20
CLASS PROTECTION	I
SHADE CODE	GL196 MLCS062
CABLE CHAIN BAR LENGT	n/a
CABLE TYPE	-

Fixing Bracket MLWB11

* Fixing bracket may differ for UL wired products.

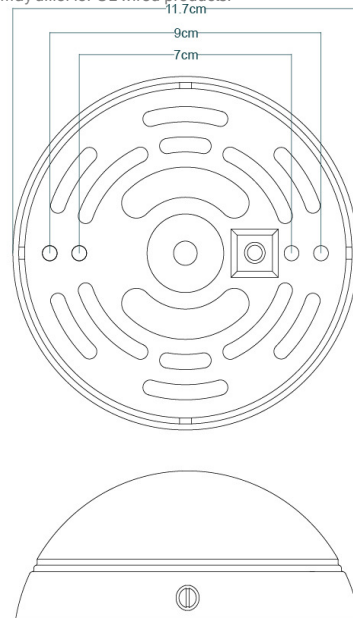

Product Notes:

1) Bulbs not included. 2) Dimensions do not include bulbs. 3) All products are individually made-to-order and therefore may differ slightly within manufacturing tolerances. 4) Cable / chain can be shortened during installation. Longer cable / chain lengths available on request. 5) Additional colour finishes may be available on request. 6) UL wired products operate at 110/120v with the appropriate lamp holder. 7) Twisted cable is not available for UL wired products. Round cable in black or brown only is supplied instead. 8) Refer to our website for a full list of terms and conditions.



POWDER-COATED
MATTE BLACK

MATERIAL	Brass Ceramic Glass
HEIGHT	n/a
WIDTH DIAMETER	21cm 8.27"
LENGTH PROJECTION	13cm 5.12"
WEIGHT	0.7KG 1.54lbs
LAMP HOLDER	G9
MAX WATTAGE	5W x 1
VOLTAGE	220/240v or 110/120v*
IP RATING	20
CLASS PROTECTION	I
SHADE CODE	GL208 MLCS062
CABLE CHAIN BAR LENGT	n/a
CABLE TYPE	-

Fixing Bracket MLWB11

* Fixing bracket may differ for UL wired products.

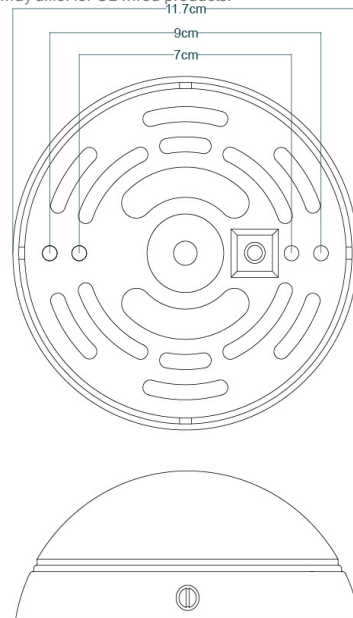

Product Notes:

1) Bulbs not included. 2) Dimensions do not include bulbs. 3) All products are individually made-to-order and therefore may differ slightly within manufacturing tolerances. 4) Cable / chain can be shortened during installation. Longer cable / chain lengths available on request. 5) Additional colour finishes may be available on request. 6) UL wired products operate at 110/120v with the appropriate lamp holder. 7) Twisted cable is not available for UL wired products. Round cable in black or brown only is supplied instead. 8) Refer to our website for a full list of terms and conditions.



MATERIAL	Brass Ceramic Glass
HEIGHT	n/a
WIDTH DIAMETER	21cm 8.27"
LENGTH PROJECTION	13cm 5.12"
WEIGHT	0.7KG 1.54lbs
LAMP HOLDER	G9
MAX WATTAGE	5W x 1
VOLTAGE	220/240v or 110/120v*
IP RATING	20
CLASS PROTECTION	I
SHADE CODE	GL192 MLCS062
CABLE CHAIN BAR LENGT	n/a
CABLE TYPE	-

Fixing Bracket MLWB11

* Fixing bracket may differ for UL wired products.

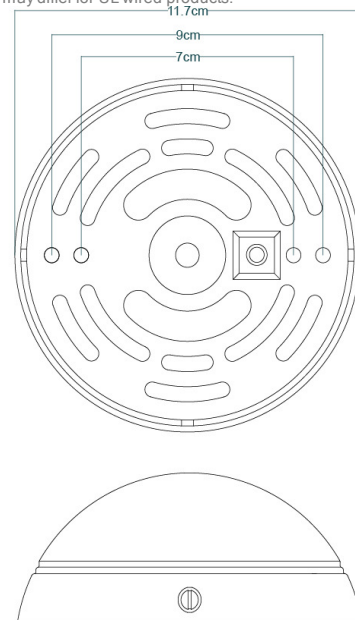

Product Notes:

1) Bulbs not included. 2) Dimensions do not include bulbs. 3) All products are individually made-to-order and therefore may differ slightly within manufacturing tolerances. 4) Cable / chain can be shortened during installation. Longer cable / chain lengths available on request. 5) Additional colour finishes may be available on request. 6) UL wired products operate at 110/120v with the appropriate lamp holder. 7) Twisted cable is not available for UL wired products. Round cable in black or brown only is supplied instead. 8) Refer to our website for a full list of terms and conditions.

RIVALE Ceramic Ceiling Fitting MLCMCF022POLBRSCCL Polished Brass



MATERIAL	Brass Ceramic Glass
HEIGHT	n/a
WIDTH DIAMETER	21cm 8.27"
LENGTH PROJECTION	13cm 5.12"
WEIGHT	0.7KG 1.54lbs
LAMP HOLDER	G9
MAX WATTAGE	5W x 1
VOLTAGE	220/240v or 110/120v*
IP RATING	20
CLASS PROTECTION	I
SHADE CODE	GL196 MLCS062
CABLE CHAIN BAR LENGT	n/a
CABLE TYPE	-

Fixing Bracket MLWB11

* Fixing bracket may differ for UL wired products.

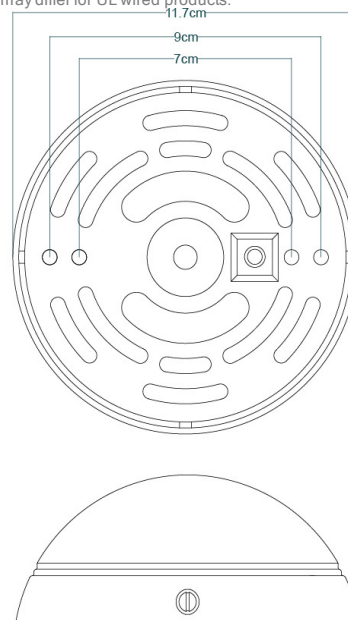

Product Notes:

1) Bulbs not included. 2) Dimensions do not include bulbs. 3) All products are individually made-to-order and therefore may differ slightly within manufacturing tolerances. 4) Cable / chain can be shortened during installation. Longer cable / chain lengths available on request. 5) Additional colour finishes may be available on request. 6) UL wired products operate at 110/120v with the appropriate lamp holder. 7) Twisted cable is not available for UL wired products. Round cable in black or brown only is supplied instead. 8) Refer to our website for a full list of terms and conditions.



MATERIAL	Brass Ceramic Glass
HEIGHT	n/a
WIDTH DIAMETER	21cm 8.27"
LENGTH PROJECTION	13cm 5.12"
WEIGHT	0.7KG 1.54lbs
LAMP HOLDER	G9
MAX WATTAGE	5W x 1
VOLTAGE	220/240v or 110/120v*
IP RATING	20
CLASS PROTECTION	I
SHADE CODE	GL208 MLCS062
CABLE CHAIN BAR LENGT	n/a
CABLE TYPE	-

Fixing Bracket MLWB11

* Fixing bracket may differ for UL wired products.

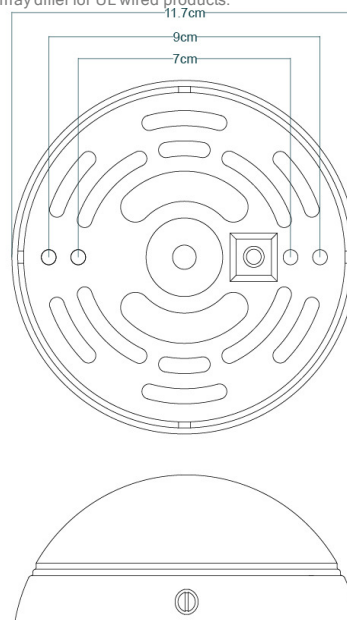

Product Notes:

1) Bulbs not included. 2) Dimensions do not include bulbs. 3) All products are individually made-to-order and therefore may differ slightly within manufacturing tolerances. 4) Cable / chain can be shortened during installation. Longer cable / chain lengths available on request. 5) Additional colour finishes may be available on request. 6) UL wired products operate at 110/120v with the appropriate lamp holder. 7) Twisted cable is not available for UL wired products. Round cable in black or brown only is supplied instead. 8) Refer to our website for a full list of terms and conditions.



MATERIAL	Brass Ceramic Glass
HEIGHT	n/a
WIDTH DIAMETER	21cm 8.27"
LENGTH PROJECTION	13cm 5.12"
WEIGHT	0.7KG 1.54lbs
LAMP HOLDER	G9
MAX WATTAGE	5W x 1
VOLTAGE	220/240v or 110/120v *
IP RATING	20
CLASS PROTECTION	I
SHADE CODE	GL192 MLCS062
CABLE CHAIN BAR LENGT	n/a
CABLE TYPE	-

Fixing Bracket MLWB11

* Fixing bracket may differ for UL wired products.

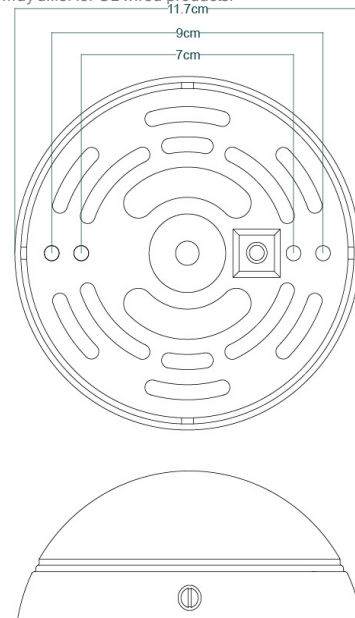

Product Notes:

1) Bulbs not included. 2) Dimensions do not include bulbs. 3) All products are individually made-to-order and therefore may differ slightly within manufacturing tolerances. 4) Cable / chain can be shortened during installation. Longer cable / chain lengths available on request. 5) Additional colour finishes may be available on request. 6) UL wired products operate at 110/120v with the appropriate lamp holder. 7) Twisted cable is not available for UL wired products. Round cable in black or brown only is supplied instead. 8) Refer to our website for a full list of terms and conditions.



MATERIAL	Brass Ceramic Glass
HEIGHT	n/a
WIDTH DIAMETER	21cm 8.27"
LENGTH PROJECTION	13cm 5.12"
WEIGHT	0.7KG 1.54lbs
LAMP HOLDER	G9
MAX WATTAGE	5W x 1
VOLTAGE	220/240v or 110/120v*
IP RATING	20
CLASS PROTECTION	I
SHADE CODE	GL196 MLCS062
CABLE CHAIN BAR LENGT	n/a
CABLE TYPE	-

Fixing Bracket MLWB11

* Fixing bracket may differ for UL wired products.

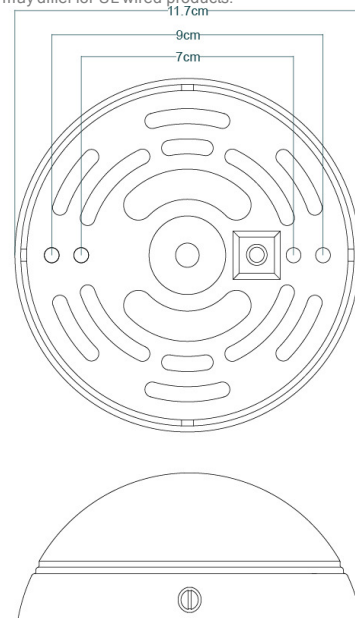

Product Notes:

1) Bulbs not included. 2) Dimensions do not include bulbs. 3) All products are individually made-to-order and therefore may differ slightly within manufacturing tolerances. 4) Cable / chain can be shortened during installation. Longer cable / chain lengths available on request. 5) Additional colour finishes may be available on request. 6) UL wired products operate at 110/120v with the appropriate lamp holder. 7) Twisted cable is not available for UL wired products. Round cable in black or brown only is supplied instead. 8) Refer to our website for a full list of terms and conditions.



MATERIAL	Brass Ceramic Glass
HEIGHT	n/a
WIDTH DIAMETER	21cm 8.27"
LENGTH PROJECTION	13cm 5.12"
WEIGHT	0.7KG 1.54lbs
LAMP HOLDER	G9
MAX WATTAGE	5W x 1
VOLTAGE	220/240v or 110/120v*
IP RATING	20
CLASS PROTECTION	I
SHADE CODE	GL208 MLCS062
CABLE CHAIN BAR LENGT	n/a
CABLE TYPE	-

Fixing Bracket MLWB11

* Fixing bracket may differ for UL wired products.

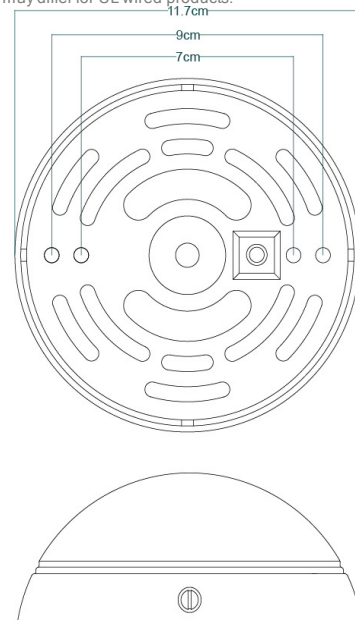

Product Notes:

1) Bulbs not included. 2) Dimensions do not include bulbs. 3) All products are individually made-to-order and therefore may differ slightly within manufacturing tolerances. 4) Cable / chain can be shortened during installation. Longer cable / chain lengths available on request. 5) Additional colour finishes may be available on request. 6) UL wired products operate at 110/120v with the appropriate lamp holder. 7) Twisted cable is not available for UL wired products. Round cable in black or brown only is supplied instead. 8) Refer to our website for a full list of terms and conditions.