

AVON 30CM Pendant

MLP463PCMBK Matt Black

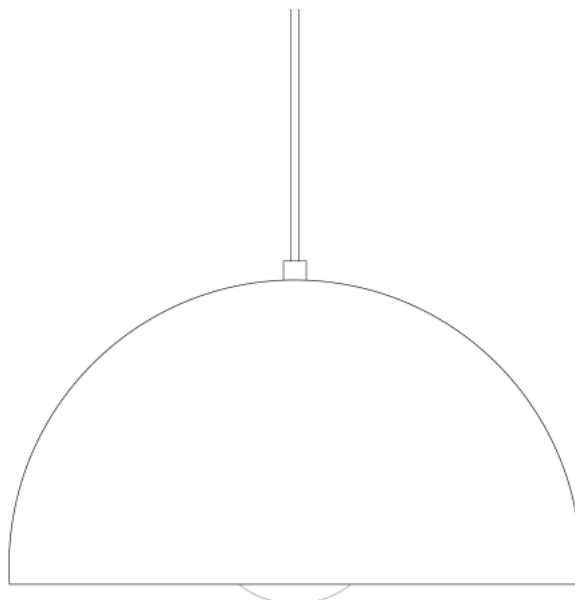

MATERIAL	Brass
HEIGHT	17cm 6.69"
WIDTH DIAMETER	30cm 11.81"
LENGTH PROJECTION	n/a
WEIGHT	1.3KG 2.87lbs
LAMPHOLDER	E27 or E26
MAX WATTAGE	40W x 1
VOLTAGE	220/240v or 110/120v
IP RATING	20
CLASS PROTECTION	I
SHADE	-
FLEX BAR CHAIN LENGT	100cm 40"
CABLE TYPE	MLCA028 2 Core Round Black Braid PVC

Fixing Bracket MLROSE31 | Matt Black

*For UL wired lights, fixing bracket may differ

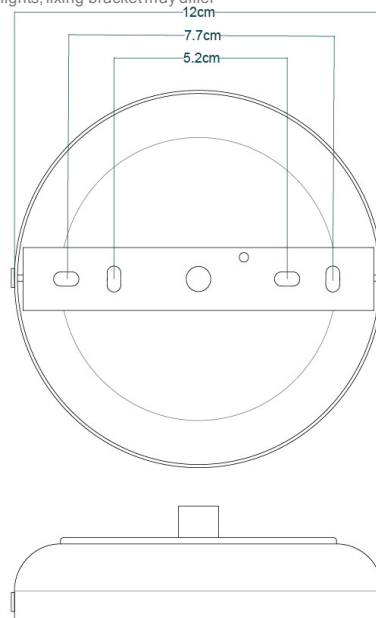

Product Notes:

1) Lamps not included with light fixture. 2) All products are individually hand crafted, therefore may differ slightly within manufacturing tolerances. 3) Please refer to: <http://www.mullanlighting.com/terms> for full list of Terms & Conditions. 4) Cable/Chain can be shortened during installation. 5) Longer Cable/Chain available on request. 6) Additional colour finishes available on request. 7.) Dimensions do not include lamps. 8.) Products wired to UL standards will operate at 110/120v with the appropriate lampholders.

AVON 30CM Pendant

MLP463PCWTE White

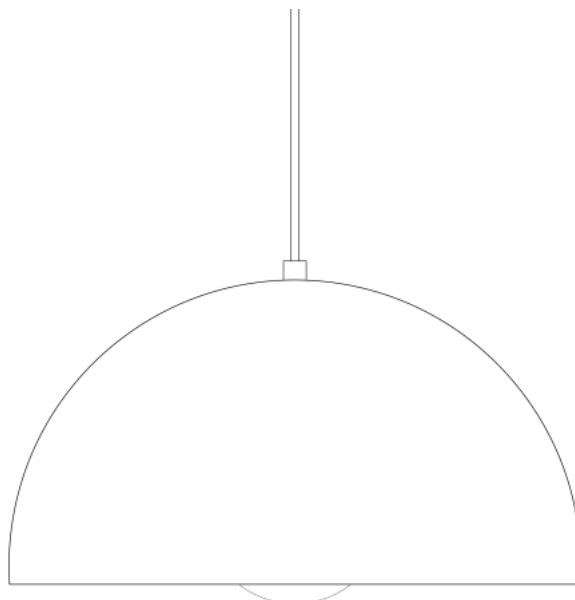

MATERIAL	Brass
HEIGHT	17cm 6.69"
WIDTH DIAMETER	30cm 11.81"
LENGTH PROJECTION	n/a
WEIGHT	1.3KG 2.87lbs
LAMPHOLDER	E27 or E26
MAX WATTAGE	40W x 1
VOLTAGE	220/240v or 110/120v
IP RATING	20
CLASS PROTECTION	I
SHADE	-
FLEX BAR CHAIN LENGT	100cm 40"
CABLE TYPE	MLCA028 2 Core Round Black Braid PVC

Fixing Bracket MLROSE31 | White

*For UL wired lights, fixing bracket may differ

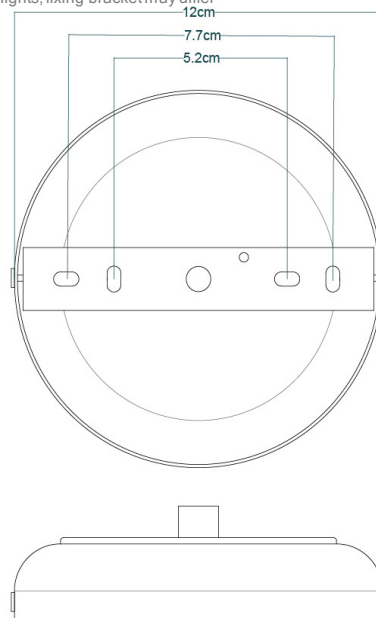

Product Notes:

1) Lamps not included with light fixture. 2) All products are individually hand crafted, therefore may differ slightly within manufacturing tolerances. 3) Please refer to: <http://www.mullanlighting.com/terms> for full list of Terms & Conditions. 4) Cable/Chain can be shortened during installation. 5) Longer Cable/Chain available on request. 6) Additional colour finishes available on request. 7.) Dimensions do not include lamps. 8.) Products wired to UL standards will operate at 110/120v with the appropriate lampholders.