

KAURI Ceramic Pendant

MLCMP065ANTBRS Antique Brass



MATERIAL	Brass Ceramic
HEIGHT	28cm 11.02"
WIDTH DIAMETER	37cm 14.57"
LENGTH PROJECTION	n/a
WEIGHT	5.65KG 12.46lbs
LAMPHOLDER	E27 x 1
MAX WATTAGE	40W x 1
VOLTAGE	220/240v
IP RATING	20
CLASS PROTECTION	I
SHADE	MLCS052
FLEX BAR CHAIN LENGT	100cm 40"
CABLE TYPE	MLCA010 2 Core Flat Brown PVC

Fixing Bracket MLWB17

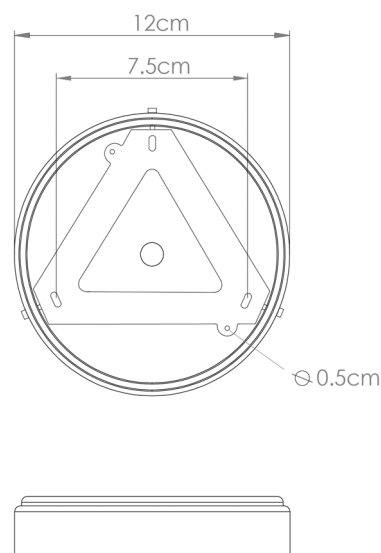

Product Notes:

1) Lamps not included with light fixture. 2) All products are individually hand crafted, therefore may differ slightly within manufacturing tolerances. 3) Please refer to: <http://www.mullanlighting.com/terms> for full list of Terms & Conditions. 4) Cable/Chain can be shortened during installation. 5) Longer Cable/Chain available on request. 6) Additional colour finishes available on request. 7.) Dimensions do not include lamps. 8.) Products wired to UL standards will operate at 110/120v with the appropriate lampholders.

KAURI Ceramic Pendant

MLCMP065ANTSLV Antique Silver



MATERIAL	Brass Ceramic
HEIGHT	28cm 11.02"
WIDTH DIAMETER	37cm 14.57"
LENGTH PROJECTION	n/a
WEIGHT	5.65KG 12.46lbs
LAMPHOLDER	E27 x 1
MAX WATTAGE	40W x 1
VOLTAGE	220/240v
IP RATING	20
CLASS PROTECTION	I
SHADE	MLCS052
FLEX BAR CHAIN LENGT	100cm 40"
CABLE TYPE	MLCA014 2 Core Flat Clear PVC

Fixing Bracket MLWB17

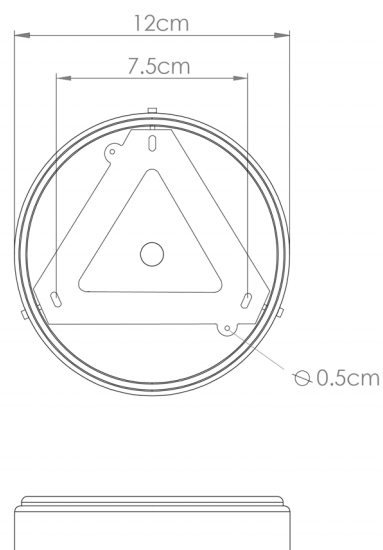

Product Notes:

1) Lamps not included with light fixture. 2) All products are individually hand crafted, therefore may differ slightly within manufacturing tolerances. 3) Please refer to: <http://www.mullanlighting.com/terms> for full list of Terms & Conditions. 4) Cable/Chain can be shortened during installation. 5) Longer Cable/Chain available on request. 6) Additional colour finishes available on request. 7.) Dimensions do not include lamps. 8.) Products wired to UL standards will operate at 110/120v with the appropriate lampholders.

KAURI Ceramic Pendant

MLCMP065PCMBK Matt Black



MATERIAL	Brass Ceramic
HEIGHT	28cm 11.02"
WIDTH DIAMETER	37cm 14.57"
LENGTH PROJECTION	n/a
WEIGHT	5.65KG 12.46lbs
LAMPHOLDER	E27 x 1
MAX WATTAGE	40W x 1
VOLTAGE	220/240v
IP RATING	20
CLASS PROTECTION	I
SHADE	MLCS052
FLEX BAR CHAIN LENGT	100cm 40"
CABLE TYPE	MLCA009

Fixing Bracket MLWB17

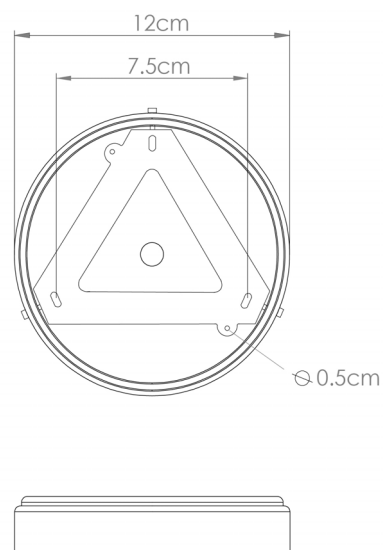

Product Notes:

1) Lamps not included with light fixture. 2) All products are individually hand crafted, therefore may differ slightly within manufacturing tolerances. 3) Please refer to: <http://www.mullanlighting.com/terms> for full list of Terms & Conditions. 4) Cable/Chain can be shortened during installation. 5) Longer Cable/Chain available on request. 6) Additional colour finishes available on request. 7.) Dimensions do not include lamps. 8.) Products wired to UL standards will operate at 110/120v with the appropriate lampholders.

KAURI Ceramic Pendant

MLCMP065POLBRS Polished Brass



MATERIAL	Brass Ceramic
HEIGHT	28cm 11.02"
WIDTH DIAMETER	37cm 14.57"
LENGTH PROJECTION	n/a
WEIGHT	5.65KG 12.46lbs
LAMPHOLDER	E27 x 1
MAX WATTAGE	40W x 1
VOLTAGE	220/240v
IP RATING	20
CLASS PROTECTION	I
SHADE	MLCS052
FLEX BAR CHAIN LENGT	100cm 40"
CABLE TYPE	MLCA038 2 Core Flat Gold PVC

Fixing Bracket MLWB17

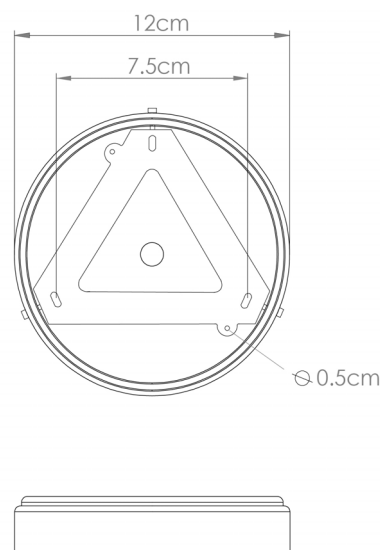

Product Notes:

1) Lamps not included with light fixture. 2) All products are individually hand crafted, therefore may differ slightly within manufacturing tolerances. 3) Please refer to: <http://www.mullanlighting.com/terms> for full list of Terms & Conditions. 4) Cable/Chain can be shortened during installation. 5) Longer Cable/Chain available on request. 6) Additional colour finishes available on request. 7.) Dimensions do not include lamps. 8.) Products wired to UL standards will operate at 110/120v with the appropriate lampholders.

KAURI Ceramic Pendant

MLCMP065SATBRS Satin Brass



MATERIAL	Brass Ceramic
HEIGHT	28cm 11.02"
WIDTH DIAMETER	37cm 14.57"
LENGTH PROJECTION	n/a
WEIGHT	5.65KG 12.46lbs
LAMPHOLDER	E27 x 1
MAX WATTAGE	40W x 1
VOLTAGE	220/240v
IP RATING	20
CLASS PROTECTION	I
SHADE	MLCS052
FLEX BAR CHAIN LENGT	100cm 40"
CABLE TYPE	MLCA038 2 Core Flat Gold PVC

Fixing Bracket MLWB17

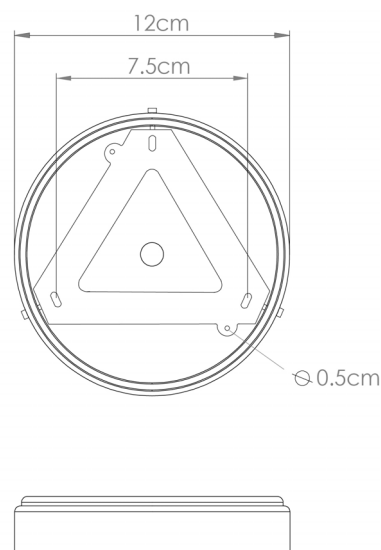

Product Notes:

1) Lamps not included with light fixture. 2) All products are individually hand crafted, therefore may differ slightly within manufacturing tolerances. 3) Please refer to: <http://www.mullanlighting.com/terms> for full list of Terms & Conditions. 4) Cable/Chain can be shortened during installation. 5) Longer Cable/Chain available on request. 6) Additional colour finishes available on request. 7.) Dimensions do not include lamps. 8.) Products wired to UL standards will operate at 110/120v with the appropriate lampholders.