

MATERIAL	Brass Glass
HEIGHT	8.75"
WIDTH DIAMETER	15.75"
LENGTH PROJECTION	n/a
WEIGHT	3.1 kg 6.8 lbs
LAMPHOLDER	E26
MAX WATTAGE	6.5W
VOLTAGE	110/120v
ENVIRONMENTAL RATING	Wet Location (IP65)
CLASS PROTECTION	Class II
SHADE	GL089 GLWP01
FLEX BAR CHAIN LENGTH	40"
CABLE TYPE	MLOCA001 Brown Fabric Braided Outdoor Rubber Cable 2 Core Round

FIXING BRACKET: MLROSE39 | Antique Brass

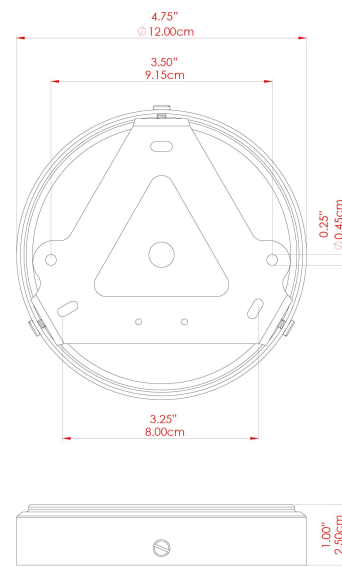

Product Notes:
 1) Bulbs not included. 2) Dimensions do not include bulbs. 3) All products are individually made-to-order and therefore may differ slightly within manufacturing tolerances. 4) Cable / chain can be shortened during installation. Longer cable / chain lengths available on request. 5) Additional color finishes may be available on request. 6) Twisted cable is not available for UL wired products. Round cable in black or brown only is supplied instead. 7) Refer to our website for a full list of terms and conditions.



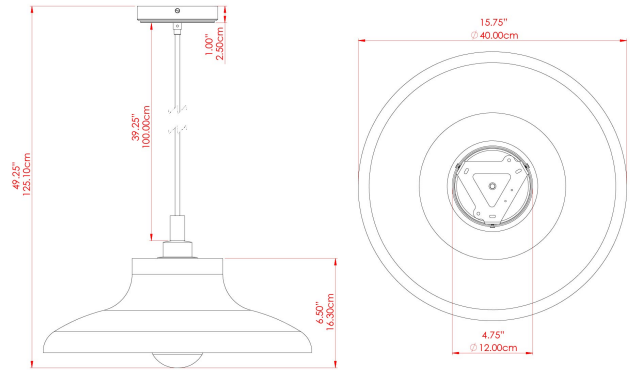

MATERIAL	Brass Glass
HEIGHT	8.75"
WIDTH DIAMETER	15.75"
LENGTH PROJECTION	n/a
WEIGHT	3.1 kg 6.8 lbs
LAMPHOLDER	E26
MAX WATTAGE	6.5W
VOLTAGE	110/120v
ENVIRONMENTAL RATING	Wet Location (IP65)
CLASS PROTECTION	Class II
SHADE	GL089 GLWP02
FLEX BAR CHAIN LENGTH	40"
CABLE TYPE	MLOCA001 Brown Fabric Braided Outdoor Rubber Cable 2 Core Round

FIXING BRACKET: MLROSE39 | Antique Brass

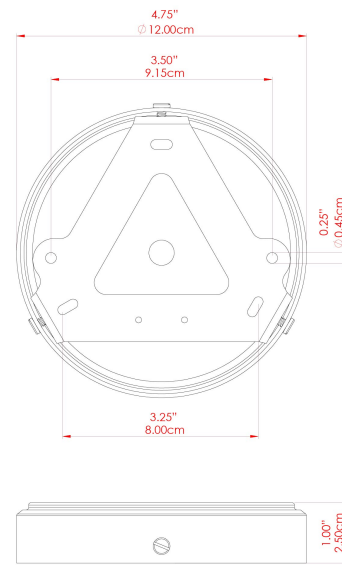

Product Notes:
 1) Bulbs not included. 2) Dimensions do not include bulbs. 3) All products are individually made-to-order and therefore may differ slightly within manufacturing tolerances. 4) Cable / chain can be shortened during installation. Longer cable / chain lengths available on request. 5) Additional color finishes may be available on request. 6) Twisted cable is not available for UL wired products. Round cable in black or brown only is supplied instead. 7) Refer to our website for a full list of terms and conditions.



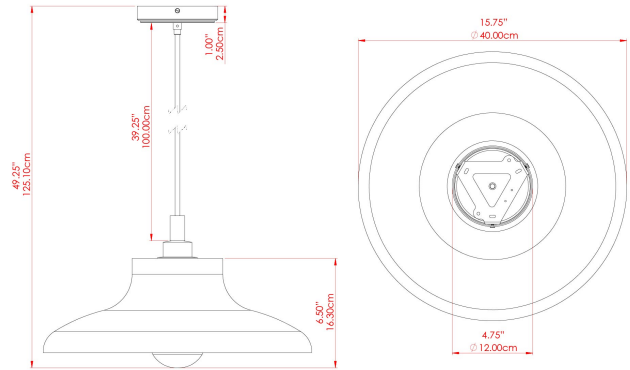

MATERIAL	Brass Glass
HEIGHT	8.75"
WIDTH DIAMETER	15.75"
LENGTH PROJECTION	n/a
WEIGHT	3.1 kg 6.8 lbs
LAMPHOLDER	E26
MAX WATTAGE	6.5W
VOLTAGE	110/120v
ENVIRONMENTAL RATING	Wet Location (IP65)
CLASS PROTECTION	Class II
SHADE	GL089 GLWP01
FLEX BAR CHAIN LENGTH	40"
CABLE TYPE	MLOCA002 Black Fabric Braided Outdoor Rubber Cable 2 Core Round

FIXING BRACKET: MLROSE39 | Antique Silver

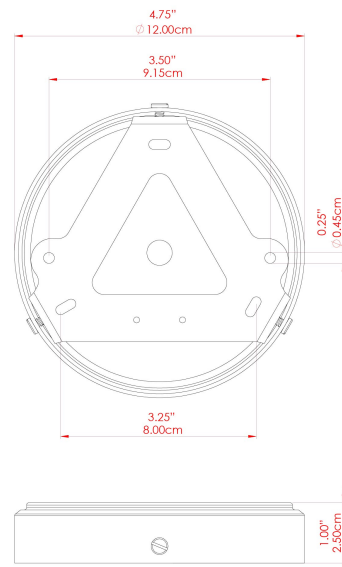

Product Notes:
 1) Bulbs not included. 2) Dimensions do not include bulbs. 3) All products are individually made-to-order and therefore may differ slightly within manufacturing tolerances. 4) Cable / chain can be shortened during installation. Longer cable / chain lengths available on request. 5) Additional color finishes may be available on request. 6) Twisted cable is not available for UL wired products. Round cable in black or brown only is supplied instead. 7) Refer to our website for a full list of terms and conditions.



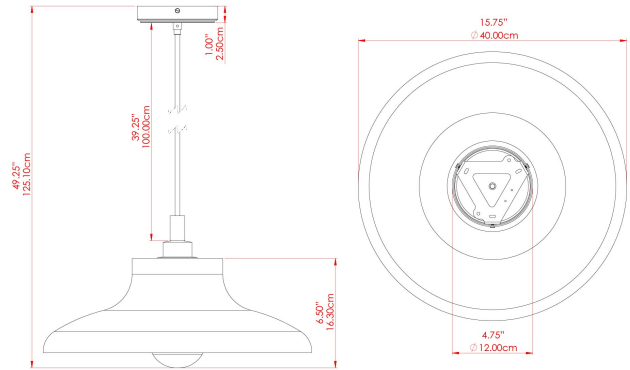

MATERIAL	Brass Glass
HEIGHT	8.75"
WIDTH DIAMETER	15.75"
LENGTH PROJECTION	n/a
WEIGHT	3.1 kg 6.8 lbs
LAMPHOLDER	E26
MAX WATTAGE	6.5W
VOLTAGE	110/120v
ENVIRONMENTAL RATING	Wet Location (IP65)
CLASS PROTECTION	Class II
SHADE	GL089 GLWP02
FLEX BAR CHAIN LENGTH	40"
CABLE TYPE	MLOCA002 Black Fabric Braided Outdoor Rubber Cable 2 Core Round

FIXING BRACKET: MLROSE39 | Antique Silver

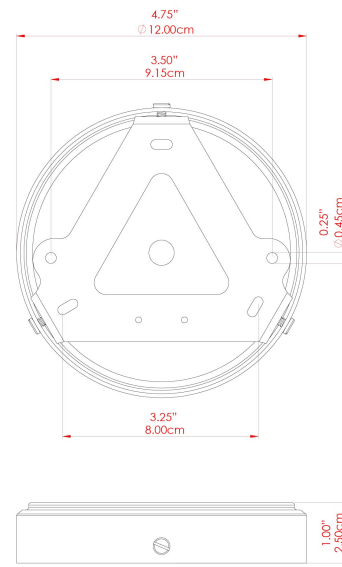

Product Notes:
 1) Bulbs not included. 2) Dimensions do not include bulbs. 3) All products are individually made-to-order and therefore may differ slightly within manufacturing tolerances. 4) Cable / chain can be shortened during installation. Longer cable / chain lengths available on request. 5) Additional color finishes may be available on request. 6) Twisted cable is not available for UL wired products. Round cable in black or brown only is supplied instead. 7) Refer to our website for a full list of terms and conditions.



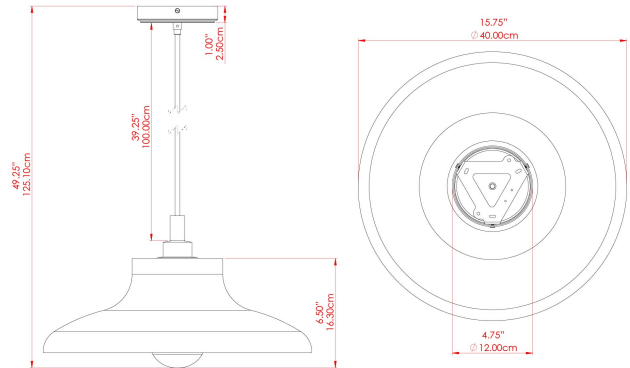

MATERIAL	Brass Glass
HEIGHT	8.75"
WIDTH DIAMETER	15.75"
LENGTH PROJECTION	n/a
WEIGHT	3.1 kg 6.8 lbs
LAMPHOLDER	E26
MAX WATTAGE	6.5W
VOLTAGE	110/120v
ENVIRONMENTAL RATING	Wet Location (IP65)
CLASS PROTECTION	Class II
SHADE	GL089 GLWP01
FLEX BAR CHAIN LENGTH	40"
CABLE TYPE	MLOCA002 Black Fabric Braided Outdoor Rubber Cable 2 Core Round

FIXING BRACKET: MLROSE39 | Matt Black

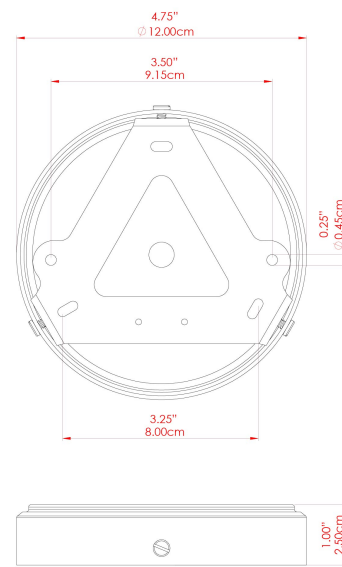

Product Notes:
 1) Bulbs not included. 2) Dimensions do not include bulbs. 3) All products are individually made-to-order and therefore may differ slightly within manufacturing tolerances. 4) Cable / chain can be shortened during installation. Longer cable / chain lengths available on request. 5) Additional color finishes may be available on request. 6) Twisted cable is not available for UL wired products. Round cable in black or brown only is supplied instead. 7) Refer to our website for a full list of terms and conditions.



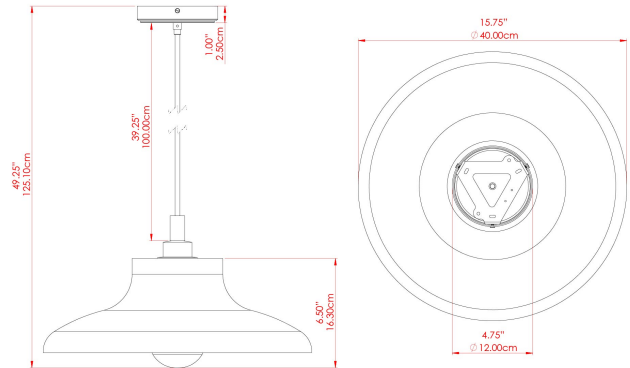

MATERIAL	Brass Glass
HEIGHT	8.75"
WIDTH DIAMETER	15.75"
LENGTH PROJECTION	n/a
WEIGHT	3.1 kg 6.8 lbs
LAMPHOLDER	E26
MAX WATTAGE	6.5W
VOLTAGE	110/120v
ENVIRONMENTAL RATING	Wet Location (IP65)
CLASS PROTECTION	Class II
SHADE	GL089 GLWP02
FLEX BAR CHAIN LENGTH	40"
CABLE TYPE	MLOCA002 Black Fabric Braided Outdoor Rubber Cable 2 Core Round

FIXING BRACKET: MLROSE39 | Matt Black

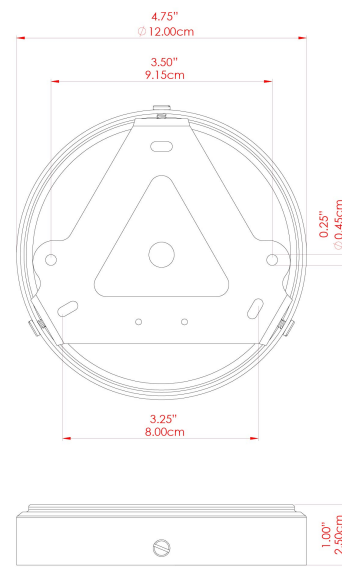

Product Notes:
 1) Bulbs not included. 2) Dimensions do not include bulbs. 3) All products are individually made-to-order and therefore may differ slightly within manufacturing tolerances. 4) Cable / chain can be shortened during installation. Longer cable / chain lengths available on request. 5) Additional color finishes may be available on request. 6) Twisted cable is not available for UL wired products. Round cable in black or brown only is supplied instead. 7) Refer to our website for a full list of terms and conditions.



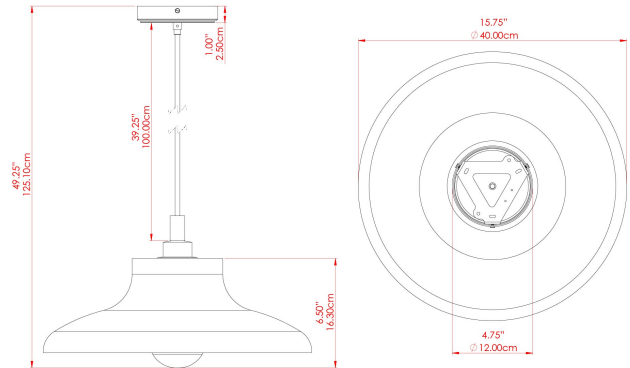

MATERIAL	Brass Glass
HEIGHT	8.75"
WIDTH DIAMETER	15.75"
LENGTH PROJECTION	n/a
WEIGHT	3.1 kg 6.8 lbs
LAMPHOLDER	E26
MAX WATTAGE	6.5W
VOLTAGE	110/120v
ENVIRONMENTAL RATING	Wet Location (IP65)
CLASS PROTECTION	Class II
SHADE	GL089 GLWP01
FLEX BAR CHAIN LENGTH	40"
CABLE TYPE	MLOCA002 Black Fabric Braided Outdoor Rubber Cable 2 Core Round

FIXING BRACKET: MLROSE39 | Natural Brass

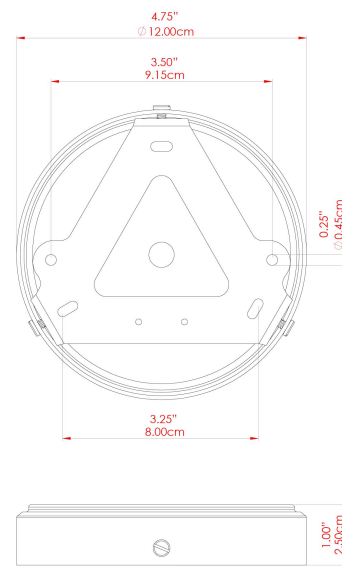

Product Notes:
 1) Bulbs not included. 2) Dimensions do not include bulbs. 3) All products are individually made-to-order and therefore may differ slightly within manufacturing tolerances. 4) Cable / chain can be shortened during installation. Longer cable / chain lengths available on request. 5) Additional color finishes may be available on request. 6) Twisted cable is not available for UL wired products. Round cable in black or brown only is supplied instead. 7) Refer to our website for a full list of terms and conditions.



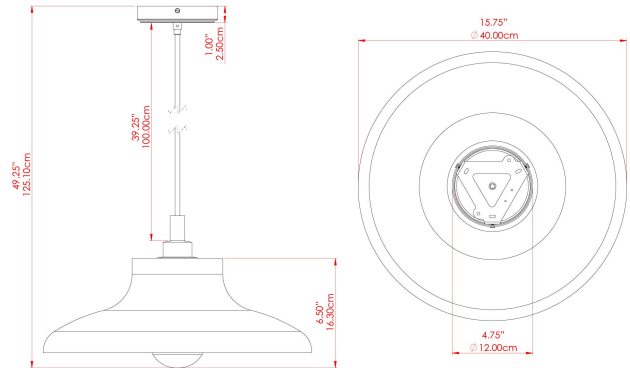

MATERIAL	Brass Glass
HEIGHT	8.75"
WIDTH DIAMETER	15.75"
LENGTH PROJECTION	n/a
WEIGHT	3.1 kg 6.8 lbs
LAMPHOLDER	E26
MAX WATTAGE	6.5W
VOLTAGE	110/120v
ENVIRONMENTAL RATING	Wet Location (IP65)
CLASS PROTECTION	Class II
SHADE	GL089 GLWP02
FLEX BAR CHAIN LENGTH	40"
CABLE TYPE	MLOCA002 Black Fabric Braided Outdoor Rubber Cable 2 Core Round

FIXING BRACKET: MLROSE39 | Natural Brass

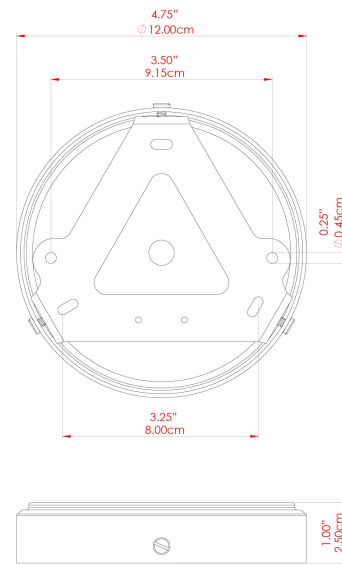

Product Notes:
 1) Bulbs not included. 2) Dimensions do not include bulbs. 3) All products are individually made-to-order and therefore may differ slightly within manufacturing tolerances. 4) Cable / chain can be shortened during installation. Longer cable / chain lengths available on request. 5) Additional color finishes may be available on request. 6) Twisted cable is not available for UL wired products. Round cable in black or brown only is supplied instead. 7) Refer to our website for a full list of terms and conditions.



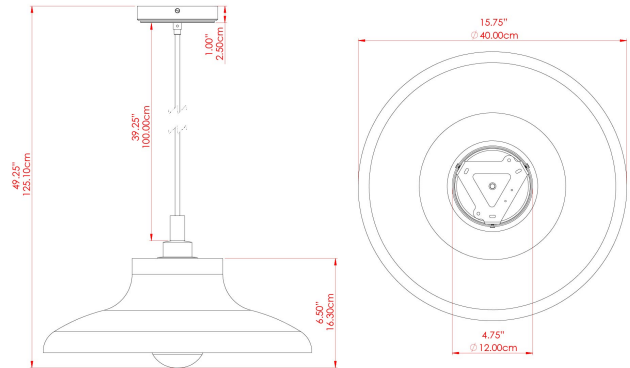

MATERIAL	Brass Glass
HEIGHT	8.75"
WIDTH DIAMETER	15.75"
LENGTH PROJECTION	n/a
WEIGHT	3.1 kg 6.8 lbs
LAMPHOLDER	E26
MAX WATTAGE	6.5W
VOLTAGE	110/120v
ENVIRONMENTAL RATING	Wet Location (IP65)
CLASS PROTECTION	Class II
SHADE	GL089 GLWP01
FLEX BAR CHAIN LENGTH	40"
CABLE TYPE	MLOCA002 Black Fabric Braided Outdoor Rubber Cable 2 Core Round

FIXING BRACKET: MLROSE39 | Polished Brass

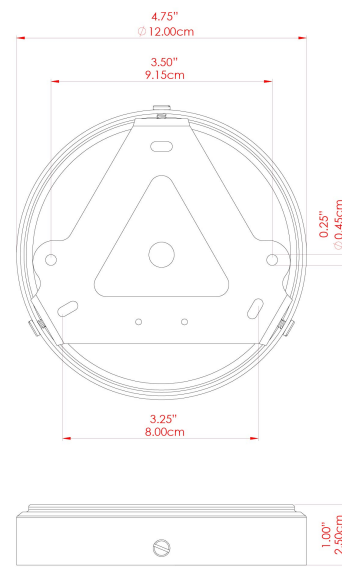

Product Notes:
 1) Bulbs not included. 2) Dimensions do not include bulbs. 3) All products are individually made-to-order and therefore may differ slightly within manufacturing tolerances. 4) Cable / chain can be shortened during installation. Longer cable / chain lengths available on request. 5) Additional color finishes may be available on request. 6) Twisted cable is not available for UL wired products. Round cable in black or brown only is supplied instead. 7) Refer to our website for a full list of terms and conditions.



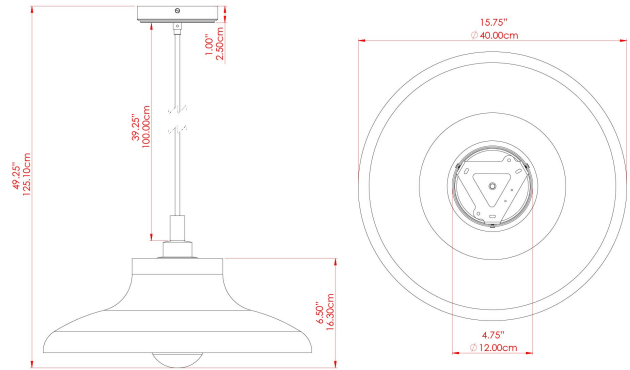

MATERIAL	Brass Glass
HEIGHT	8.75"
WIDTH DIAMETER	15.75"
LENGTH PROJECTION	n/a
WEIGHT	3.1 kg 6.8 lbs
LAMPHOLDER	E26
MAX WATTAGE	6.5W
VOLTAGE	110/120v
ENVIRONMENTAL RATING	Wet Location (IP65)
CLASS PROTECTION	Class II
SHADE	GL089 GLWP02
FLEX BAR CHAIN LENGTH	40"
CABLE TYPE	MLOCA002 Black Fabric Braided Outdoor Rubber Cable 2 Core Round

FIXING BRACKET: MLROSE39 | Polished Brass

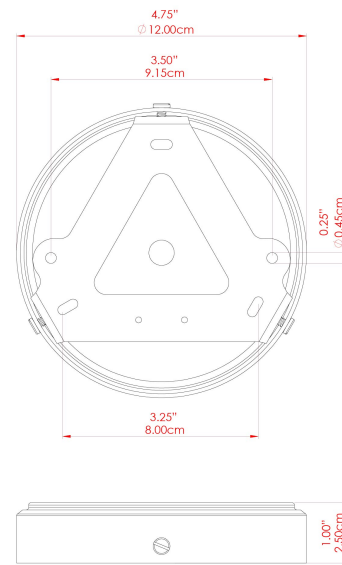

Product Notes:
 1) Bulbs not included. 2) Dimensions do not include bulbs. 3) All products are individually made-to-order and therefore may differ slightly within manufacturing tolerances. 4) Cable / chain can be shortened during installation. Longer cable / chain lengths available on request. 5) Additional color finishes may be available on request. 6) Twisted cable is not available for UL wired products. Round cable in black or brown only is supplied instead. 7) Refer to our website for a full list of terms and conditions.



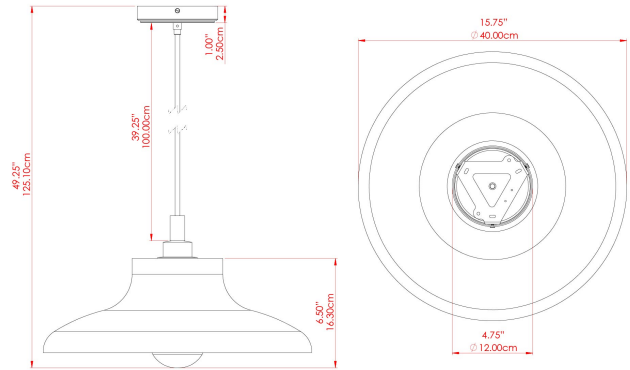

MATERIAL	Brass Glass
HEIGHT	8.75"
WIDTH DIAMETER	15.75"
LENGTH PROJECTION	n/a
WEIGHT	3.1 kg 6.8 lbs
LAMPHOLDER	E26
MAX WATTAGE	6.5W
VOLTAGE	110/120v
ENVIRONMENTAL RATING	Wet Location (IP65)
CLASS PROTECTION	Class II
SHADE	GL089 GLWP01
FLEX BAR CHAIN LENGTH	40"
CABLE TYPE	MLOCA002 Black Fabric Braided Outdoor Rubber Cable 2 Core Round

FIXING BRACKET: MLROSE39 | Polished Chrome

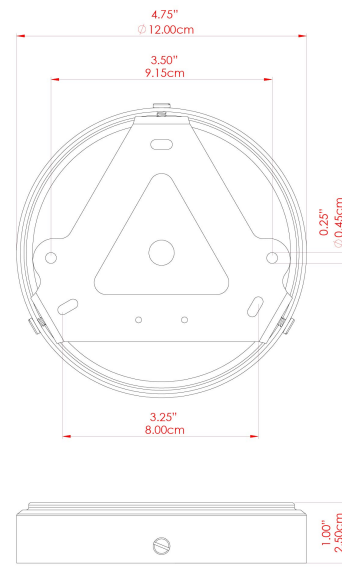

Product Notes:
 1) Bulbs not included. 2) Dimensions do not include bulbs. 3) All products are individually made-to-order and therefore may differ slightly within manufacturing tolerances. 4) Cable / chain can be shortened during installation. Longer cable / chain lengths available on request. 5) Additional color finishes may be available on request. 6) Twisted cable is not available for UL wired products. Round cable in black or brown only is supplied instead. 7) Refer to our website for a full list of terms and conditions.



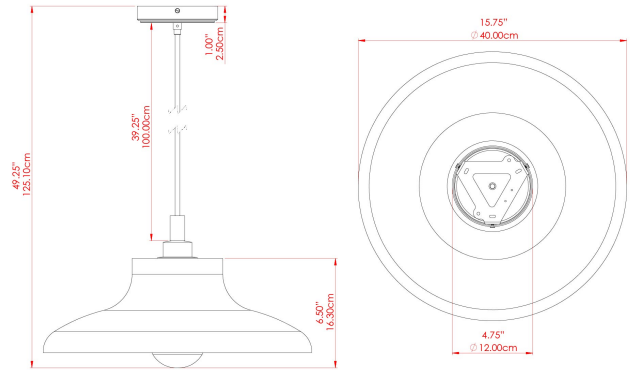

MATERIAL	Brass Glass
HEIGHT	8.75"
WIDTH DIAMETER	15.75"
LENGTH PROJECTION	n/a
WEIGHT	3.1 kg 6.8 lbs
LAMPHOLDER	E26
MAX WATTAGE	6.5W
VOLTAGE	110/120v
ENVIRONMENTAL RATING	Wet Location (IP65)
CLASS PROTECTION	Class II
SHADE	GL089 GLWP02
FLEX BAR CHAIN LENGTH	40"
CABLE TYPE	MLOCA002 Black Fabric Braided Outdoor Rubber Cable 2 Core Round

FIXING BRACKET: MLROSE39 | Polished Chrome

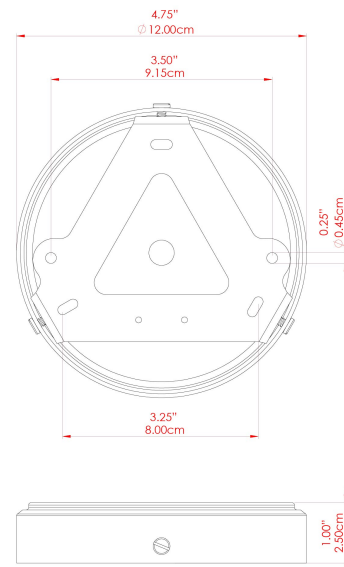

Product Notes:
 1) Bulbs not included. 2) Dimensions do not include bulbs. 3) All products are individually made-to-order and therefore may differ slightly within manufacturing tolerances. 4) Cable / chain can be shortened during installation. Longer cable / chain lengths available on request. 5) Additional color finishes may be available on request. 6) Twisted cable is not available for UL wired products. Round cable in black or brown only is supplied instead. 7) Refer to our website for a full list of terms and conditions.



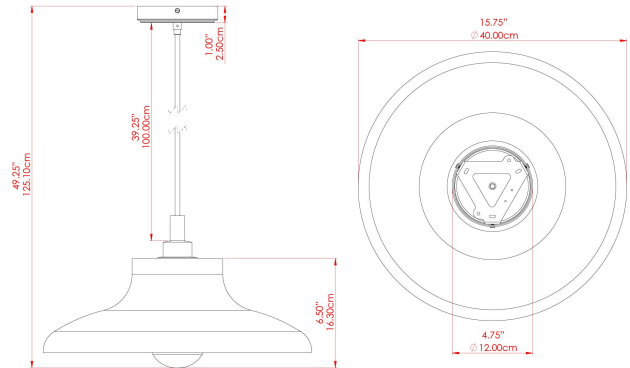

MATERIAL	Brass Glass
HEIGHT	8.75"
WIDTH DIAMETER	15.75"
LENGTH PROJECTION	n/a
WEIGHT	3.1 kg 6.8 lbs
LAMPHOLDER	E26
MAX WATTAGE	6.5W
VOLTAGE	110/120v
ENVIRONMENTAL RATING	Wet Location (IP65)
CLASS PROTECTION	Class II
SHADE	GL089 GLWP01
FLEX BAR CHAIN LENGTH	40"
CABLE TYPE	MLOCA002 Black Fabric Braided Outdoor Rubber Cable 2 Core Round

FIXING BRACKET: MLROSE39 | Satin Brass

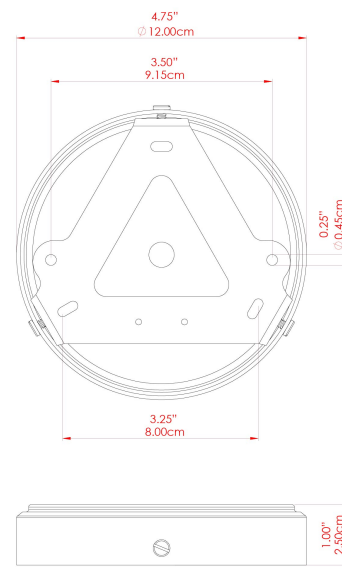

Product Notes:
 1) Bulbs not included. 2) Dimensions do not include bulbs. 3) All products are individually made-to-order and therefore may differ slightly within manufacturing tolerances. 4) Cable / chain can be shortened during installation. Longer cable / chain lengths available on request. 5) Additional color finishes may be available on request. 6) Twisted cable is not available for UL wired products. Round cable in black or brown only is supplied instead. 7) Refer to our website for a full list of terms and conditions.



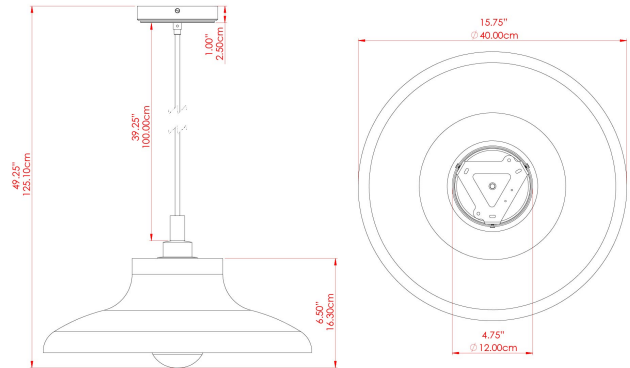

MATERIAL	Brass Glass
HEIGHT	8.75"
WIDTH DIAMETER	15.75"
LENGTH PROJECTION	n/a
WEIGHT	3.1 kg 6.8 lbs
LAMPHOLDER	E26
MAX WATTAGE	6.5W
VOLTAGE	110/120v
ENVIRONMENTAL RATING	Wet Location (IP65)
CLASS PROTECTION	Class II
SHADE	GL089 GLWP02
FLEX BAR CHAIN LENGTH	40"
CABLE TYPE	MLOCA002 Black Fabric Braided Outdoor Rubber Cable 2 Core Round

FIXING BRACKET: MLROSE39 | Satin Brass

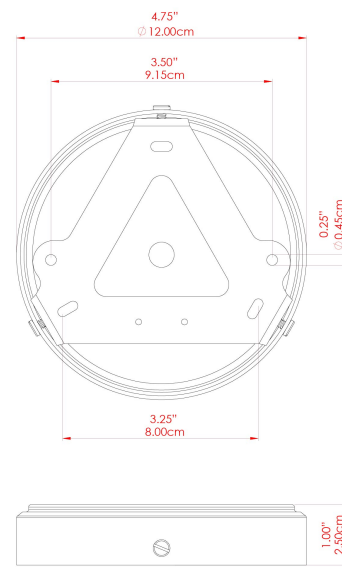

Product Notes:
 1) Bulbs not included. 2) Dimensions do not include bulbs. 3) All products are individually made-to-order and therefore may differ slightly within manufacturing tolerances. 4) Cable / chain can be shortened during installation. Longer cable / chain lengths available on request. 5) Additional color finishes may be available on request. 6) Twisted cable is not available for UL wired products. Round cable in black or brown only is supplied instead. 7) Refer to our website for a full list of terms and conditions.



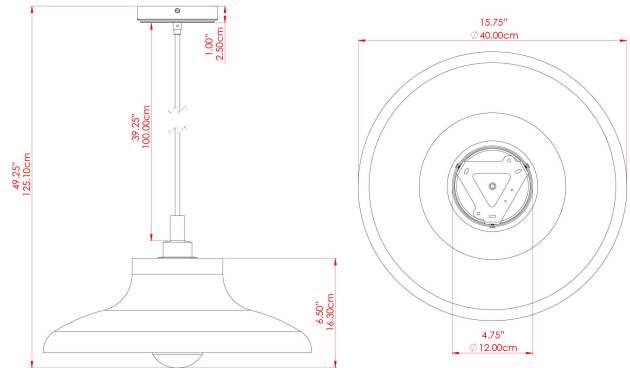

MATERIAL	Brass Glass
HEIGHT	8.75"
WIDTH DIAMETER	15.75"
LENGTH PROJECTION	n/a
WEIGHT	3.1 kg 6.8 lbs
LAMPHOLDER	E26
MAX WATTAGE	6.5W
VOLTAGE	110/120v
ENVIRONMENTAL RATING	Wet Location (IP65)
CLASS PROTECTION	Class II
SHADE	GL089 GLWP01
FLEX BAR CHAIN LENGTH	40"
CABLE TYPE	MLOCA002 Black Fabric Braided Outdoor Rubber Cable 2 Core Round

FIXING BRACKET: MLROSE39 | White

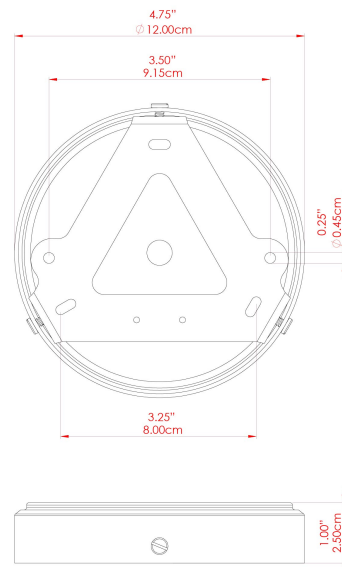

Product Notes:
 1) Bulbs not included. 2) Dimensions do not include bulbs. 3) All products are individually made-to-order and therefore may differ slightly within manufacturing tolerances. 4) Cable / chain can be shortened during installation. Longer cable / chain lengths available on request. 5) Additional color finishes may be available on request. 6) Twisted cable is not available for UL wired products. Round cable in black or brown only is supplied instead. 7) Refer to our website for a full list of terms and conditions.



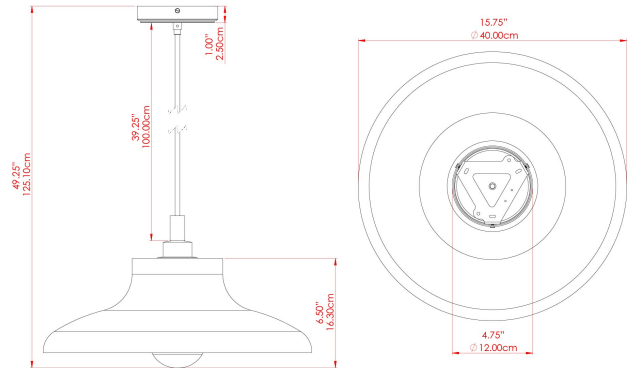

MATERIAL	Brass Glass
HEIGHT	8.75"
WIDTH DIAMETER	15.75"
LENGTH PROJECTION	n/a
WEIGHT	3.1 kg 6.8 lbs
LAMPHOLDER	E26
MAX WATTAGE	6.5W
VOLTAGE	110/120v
ENVIRONMENTAL RATING	Wet Location (IP65)
CLASS PROTECTION	Class II
SHADE	GL089 GLWP02
FLEX BAR CHAIN LENGTH	40"
CABLE TYPE	MLOCA002 Black Fabric Braided Outdoor Rubber Cable 2 Core Round

FIXING BRACKET: MLROSE39 | White

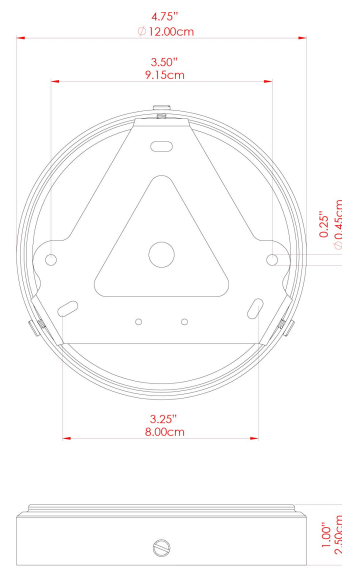

Product Notes:
 1) Bulbs not included. 2) Dimensions do not include bulbs. 3) All products are individually made-to-order and therefore may differ slightly within manufacturing tolerances. 4) Cable / chain can be shortened during installation. Longer cable / chain lengths available on request. 5) Additional color finishes may be available on request. 6) Twisted cable is not available for UL wired products. Round cable in black or brown only is supplied instead. 7) Refer to our website for a full list of terms and conditions.

