

# SEVILLE Ceramic Table Lamp

MLCMTL042ANTBRS Antique Brass

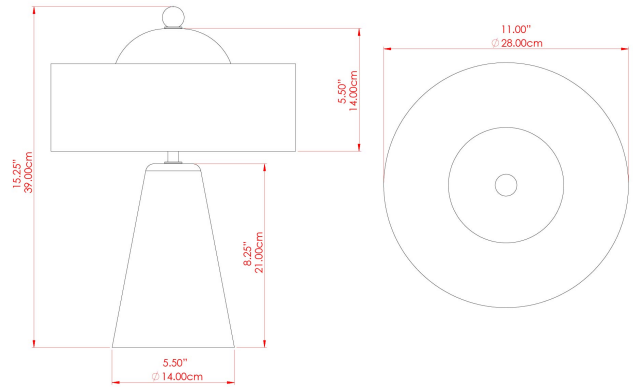

MATERIAL	Ceramic   Brass
HEIGHT	40cm
WIDTH   DIAMETER	28cm
LENGTH   PROJECTION	n/a
WEIGHT	4.9 kg
LAMPHOLDER	G9
MAX WATTAGE	5W
VOLTAGE	220/240v
IP RATING	IP20
CLASS PROTECTION	Class I
SHADE	MLCS081
FLEX   BAR   CHAIN LENGTH	n/a
CABLE TYPE	MLCA002   Brown Fabric Braided Cable   2 Core Twisted

FIXING BRACKET: -



Product Notes:  
 1) Bulbs not included. 2) Dimensions do not include bulbs. 3) All products are individually made-to-order and therefore may differ slightly within manufacturing tolerances. 4) Cable / chain can be shortened during installation. Longer cable / chain lengths available on request. 5) Additional colour finishes may be available on request. 6) Refer to our website for a full list of terms and conditions.



# SEVILLE Ceramic Table Lamp

MLCMTL042ANTSLV Antique Silver

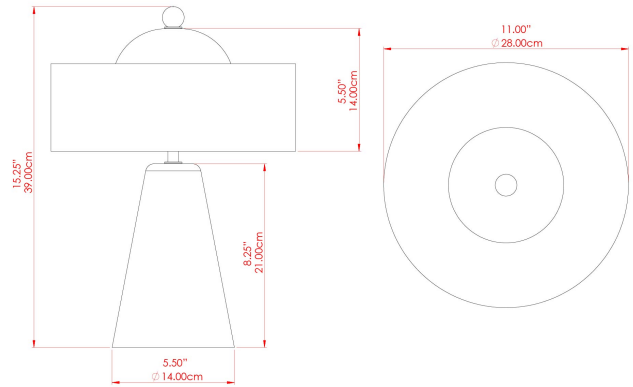

MATERIAL	Ceramic   Brass
HEIGHT	40cm
WIDTH   DIAMETER	28cm
LENGTH   PROJECTION	n/a
WEIGHT	4.9 kg
LAMPHOLDER	G9
MAX WATTAGE	5W
VOLTAGE	220/240v
IP RATING	IP20
CLASS PROTECTION	Class I
SHADE	MLCS081
FLEX   BAR   CHAIN LENGTH	n/a
CABLE TYPE	MLCA001   Black Fabric Braided Cable   2 Core Twisted

FIXING BRACKET: -



Product Notes:  
 1) Bulbs not included. 2) Dimensions do not include bulbs. 3) All products are individually made-to-order and therefore may differ slightly within manufacturing tolerances. 4) Cable / chain can be shortened during installation. Longer cable / chain lengths available on request. 5) Additional colour finishes may be available on request. 6) Refer to our website for a full list of terms and conditions.



# SEVILLE Ceramic Table Lamp

MLCMTL042PCMBK Matt Black

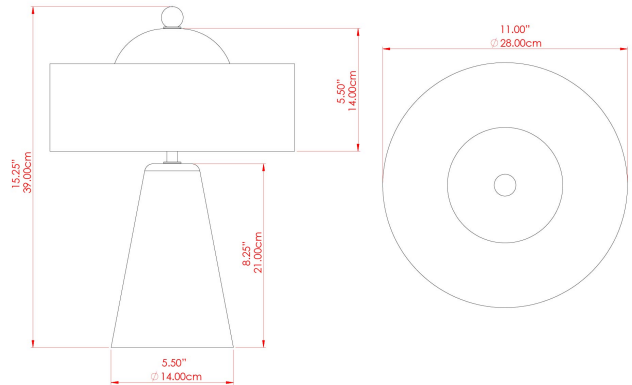

MATERIAL	Ceramic   Brass
HEIGHT	40cm
WIDTH   DIAMETER	28cm
LENGTH   PROJECTION	n/a
WEIGHT	4.9 kg
LAMPHOLDER	G9
MAX WATTAGE	5W
VOLTAGE	220/240v
IP RATING	IP20
CLASS PROTECTION	Class I
SHADE	MLCS081
FLEX   BAR   CHAIN LENGTH	n/a
CABLE TYPE	MLCA001   Black Fabric Braided Cable   2 Core Twisted

FIXING BRACKET: -



WWW.MULLANLIGHTING.COM

**Product Notes:**

1) Bulbs not included. 2) Dimensions do not include bulbs. 3) All products are individually made-to-order and therefore may differ slightly within manufacturing tolerances. 4) Cable / chain can be shortened during installation. Longer cable / chain lengths available on request. 5) Additional colour finishes may be available on request. 6) Refer to our website for a full list of terms and conditions.



# SEVILLE Ceramic Table Lamp

MLCMTL042POLBRS Polished Brass

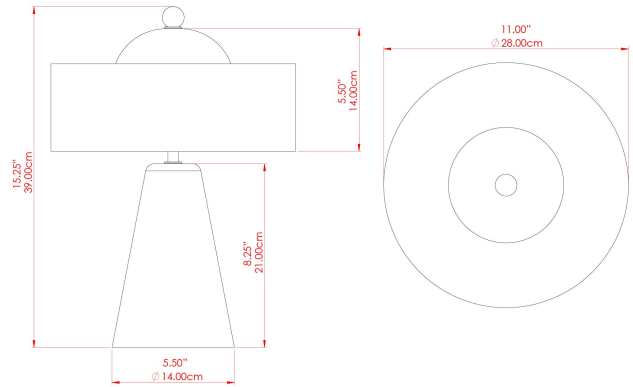

MATERIAL	Ceramic   Brass
HEIGHT	40cm
WIDTH   DIAMETER	28cm
LENGTH   PROJECTION	n/a
WEIGHT	4.9 kg
LAMPHOLDER	G9
MAX WATTAGE	5W
VOLTAGE	220/240v
IP RATING	IP20
CLASS PROTECTION	Class I
SHADE	MLCS081
FLEX   BAR   CHAIN LENGTH	n/a
CABLE TYPE	MLCA001   Black Fabric Braided Cable   2 Core Twisted

FIXING BRACKET: -



Product Notes:  
 1) Bulbs not included. 2) Dimensions do not include bulbs. 3) All products are individually made-to-order and therefore may differ slightly within manufacturing tolerances. 4) Cable / chain can be shortened during installation. Longer cable / chain lengths available on request. 5) Additional colour finishes may be available on request. 6) Refer to our website for a full list of terms and conditions.



# SEVILLE Ceramic Table Lamp

MLCMTL042SATBRS Satin Brass

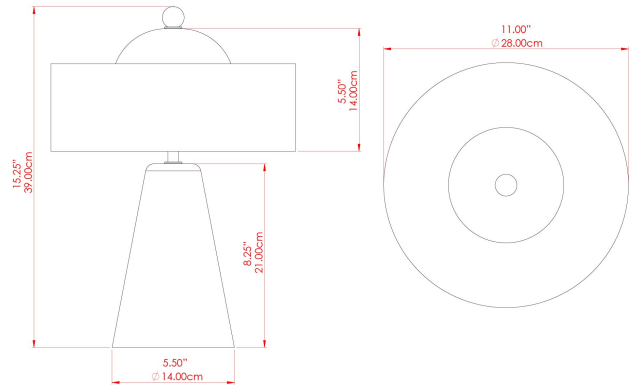

MATERIAL	Ceramic   Brass
HEIGHT	40cm
WIDTH   DIAMETER	28cm
LENGTH   PROJECTION	n/a
WEIGHT	4.9 kg
LAMPHOLDER	G9
MAX WATTAGE	5W
VOLTAGE	220/240v
IP RATING	IP20
CLASS PROTECTION	Class I
SHADE	MLCS081
FLEX   BAR   CHAIN LENGTH	n/a
CABLE TYPE	MLCA001   Black Fabric Braided Cable   2 Core Twisted

FIXING BRACKET: -



Product Notes:  
 1) Bulbs not included. 2) Dimensions do not include bulbs. 3) All products are individually made-to-order and therefore may differ slightly within manufacturing tolerances. 4) Cable / chain can be shortened during installation. Longer cable / chain lengths available on request. 5) Additional colour finishes may be available on request. 6) Refer to our website for a full list of terms and conditions.

