

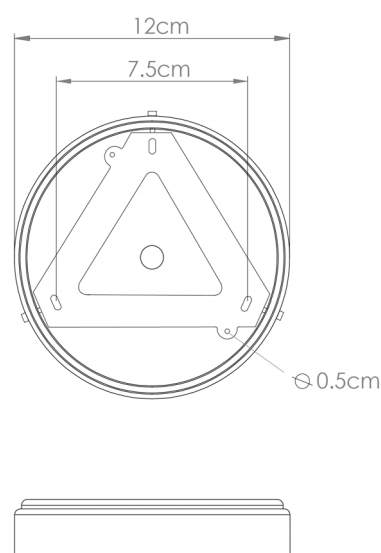

MATERIAL	BRASS CERAMIC GLASS
HEIGHT	9.5CM 3.74"
WIDTH DIAMETER	27CM 10.63"
LENGTH PROJECTION	n/a
WEIGHT	0.9KG 1.98lbs
LAMPHOLDER	E27 x 1
MAX WATTAGE	6.5W x 1
VOLTAGE	220/240v
IP RATING	44
CLASS PROTECTION	II
SHADE	MLCS016 BO-IP.GLASS GLWP01
FLEX BAR CHAIN LENGT	n/a
CABLE TYPE	MLOCA001 2 Core Round Brown Braid Rubber

Fixing Bracket MLROSE39



Product Notes:

1) Lamps not included with light fixture. 2) All products are individually hand crafted, therefore may differ slightly within manufacturing tolerances. 3) Please refer to: <http://www.mullanlighting.com/terms> for full list of Terms & Conditions. 4) Cable/Chain can be shortened during installation. 5) Longer Cable/Chain available on request. 6) Additional colour finishes available on request. 7.) Dimensions do not include lamps. 8.) Products wired to UL standards will operate at 110/120v with the appropriate lampholders.



MATERIAL	BRASS CERAMIC GLASS
HEIGHT	9.5CM 3.74"
WIDTH DIAMETER	27CM 10.63"
LENGTH PROJECTION	n/a
WEIGHT	0.9KG 1.98lbs
LAMPHOLDER	E27 x 1
MAX WATTAGE	6.5W x 1
VOLTAGE	220/240v
IP RATING	44
CLASS PROTECTION	II
SHADE	MLCS016 BO-IP.GLASS GLWP01
FLEX BAR CHAIN LENGT	n/a
CABLE TYPE	MLOCA002 2 Core Round Black Braid Rubber

Fixing Bracket MLROSE39

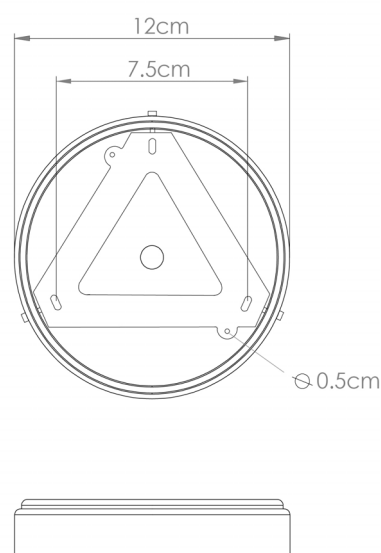

Product Notes:

1) Lamps not included with light fixture. 2) All products are individually hand crafted, therefore may differ slightly within manufacturing tolerances. 3) Please refer to: <http://www.mullanlighting.com/terms> for full list of Terms & Conditions. 4) Cable/Chain can be shortened during installation. 5) Longer Cable/Chain available on request. 6) Additional colour finishes available on request. 7.) Dimensions do not include lamps. 8.) Products wired to UL standards will operate at 110/120v with the appropriate lampholders.



MATERIAL	BRASS CERAMIC GLASS
HEIGHT	9.5CM 3.74"
WIDTH DIAMETER	27CM 10.63"
LENGTH PROJECTION	n/a
WEIGHT	0.9KG 1.98lbs
LAMPHOLDER	E27 x 1
MAX WATTAGE	6.5W x 1
VOLTAGE	220/240v
IP RATING	44
CLASS PROTECTION	II
SHADE	MLCS016 BO.IP.GLASS GLWP01
FLEX BAR CHAIN LENGT	n/a
CABLE TYPE	MLOCA002 2 Core Round Black Braid Rubber

Fixing Bracket MLROSE39

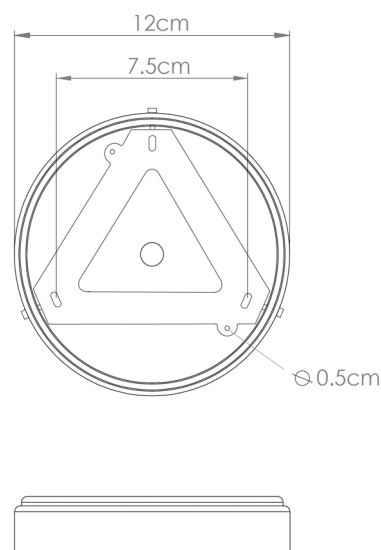

Product Notes:

1) Lamps not included with light fixture. 2) All products are individually hand crafted, therefore may differ slightly within manufacturing tolerances. 3) Please refer to: <http://www.mullanlighting.com/terms> for full list of Terms & Conditions. 4) Cable/Chain can be shortened during installation. 5) Longer Cable/Chain available on request. 6) Additional colour finishes available on request. 7.) Dimensions do not include lamps. 8.) Products wired to UL standards will operate at 110/120v with the appropriate lampholders.



MATERIAL	BRASS CERAMIC GLASS
HEIGHT	9.5CM 3.74"
WIDTH DIAMETER	27CM 10.63"
LENGTH PROJECTION	n/a
WEIGHT	0.9KG 1.98lbs
LAMPHOLDER	E27 x 1
MAX WATTAGE	6.5W x 1
VOLTAGE	220/240v
IP RATING	44
CLASS PROTECTION	II
SHADE	MLCS016 BO-IP.GLASS GLWP01
FLEX BAR CHAIN LENGT	n/a
CABLE TYPE	MLOCA002 2 Core Round Black Braid Rubber

Fixing Bracket MLROSE39

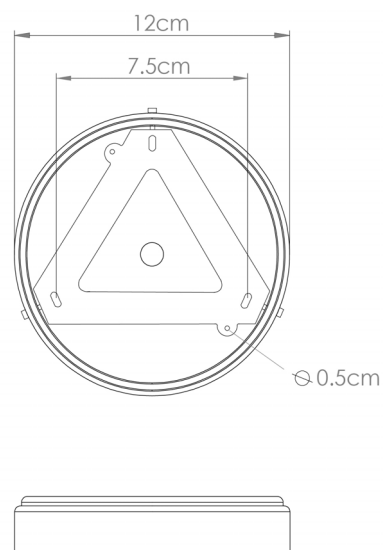

Product Notes:

1) Lamps not included with light fixture. 2) All products are individually hand crafted, therefore may differ slightly within manufacturing tolerances. 3) Please refer to: <http://www.mullanlighting.com/terms> for full list of Terms & Conditions. 4) Cable/Chain can be shortened during installation. 5) Longer Cable/Chain available on request. 6) Additional colour finishes available on request. 7.) Dimensions do not include lamps. 8.) Products wired to UL standards will operate at 110/120v with the appropriate lampholders.



MATERIAL	BRASS CERAMIC GLASS
HEIGHT	9.5CM 3.74"
WIDTH DIAMETER	27CM 10.63"
LENGTH PROJECTION	n/a
WEIGHT	0.9KG 1.98lbs
LAMPHOLDER	E27 x 1
MAX WATTAGE	6.5W x 1
VOLTAGE	220/240v
IP RATING	44
CLASS PROTECTION	II
SHADE	MLCS016 BO-IP.GLASS GLWP01
FLEX BAR CHAIN LENGT	n/a
CABLE TYPE	MLOCA002 2 Core Round Black Braid Rubber

Fixing Bracket MLROSE39

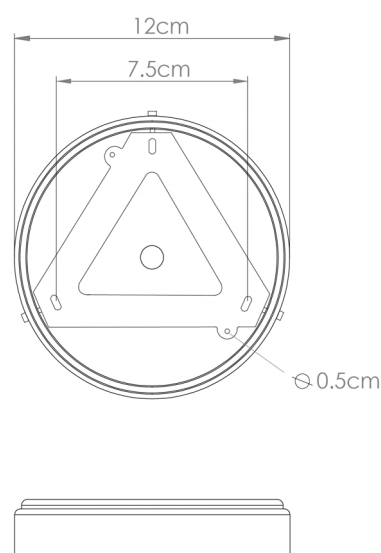

Product Notes:

1) Lamps not included with light fixture. 2) All products are individually hand crafted, therefore may differ slightly within manufacturing tolerances. 3) Please refer to: <http://www.mullanlighting.com/terms> for full list of Terms & Conditions. 4) Cable/Chain can be shortened during installation. 5) Longer Cable/Chain available on request. 6) Additional colour finishes available on request. 7.) Dimensions do not include lamps. 8.) Products wired to UL standards will operate at 110/120v with the appropriate lampholders.