

MATERIAL	Brass Glass
HEIGHT	28cm 11.02"
WIDTH DIAMETER	20cm 7.87"
LENGTH PROJECTION	n/a
WEIGHT	2.53KG 5.58lbs
LAMP HOLDER	E27 or E26 *
MAX WATTAGE	6.5W x 1
VOLTAGE	220/240v or 110/120v *
IP RATING	65
CLASS PROTECTION	II
SHADE CODE	GL129 GLWP01
CABLE CHAIN BAR LENGT	100cm 40"
CABLE TYPE	MLOCA001 2 Core Round Brown Braid Rubber

Fixing Bracket MLROSE31 | Antique Brass

* Fixing bracket may differ for UL wired products.

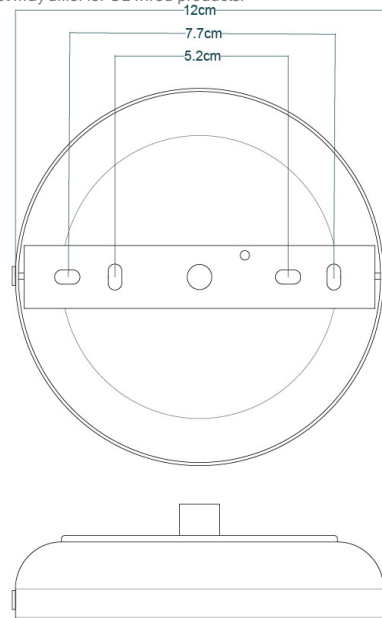

Product Notes:

1) Bulbs not included. 2) Dimensions do not include bulbs. 3) All products are individually made-to-order and therefore may differ slightly within manufacturing tolerances. 4) Cable / chain can be shortened during installation. Longer cable / chain lengths available on request. 5) Additional colour finishes may be available on request. 6) UL wired products operate at 110/120v with the appropriate lamp holder. 7) Twisted cable is not available for UL wired products. Round cable in black or brown only is supplied instead. 8) Refer to our website for a full list of terms and conditions.

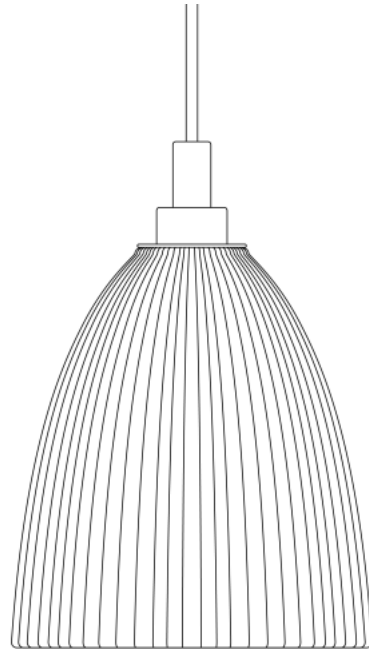

MATERIAL	Brass Glass
HEIGHT	28cm 11.02"
WIDTH DIAMETER	20cm 7.87"
LENGTH PROJECTION	n/a
WEIGHT	2.53KG 5.58lbs
LAMP HOLDER	E27 or E26 *
MAX WATTAGE	6.5W x 1
VOLTAGE	220/240v or 110/120v *
IP RATING	65
CLASS PROTECTION	II
SHADE CODE	GL129 GLWP02
CABLE CHAIN BAR LENGT	100cm 40"
CABLE TYPE	MLOCA001 2 Core Round Brown Braid Rubber

Fixing Bracket MLROSE31 | Antique Brass

* Fixing bracket may differ for UL wired products.

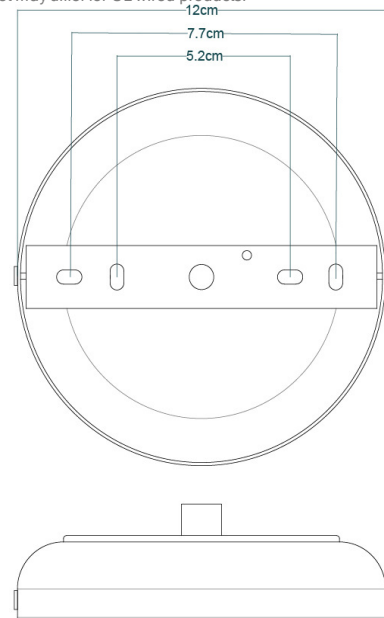

Product Notes:

1) Bulbs not included. 2) Dimensions do not include bulbs. 3) All products are individually made-to-order and therefore may differ slightly within manufacturing tolerances. 4) Cable / chain can be shortened during installation. Longer cable / chain lengths available on request. 5) Additional colour finishes may be available on request. 6) UL wired products operate at 110/120v with the appropriate lamp holder. 7) Twisted cable is not available for UL wired products. Round cable in black or brown only is supplied instead. 8) Refer to our website for a full list of terms and conditions.

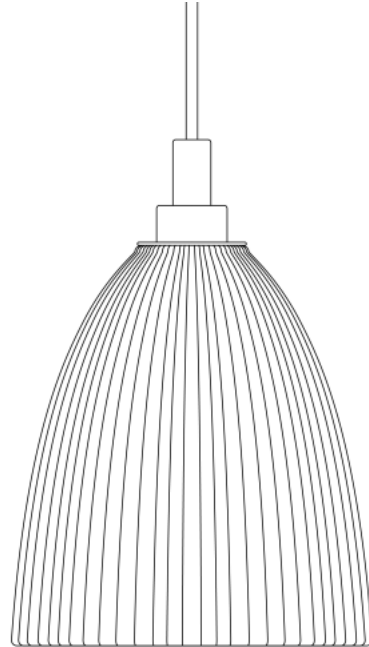

MATERIAL	Brass Glass
HEIGHT	28cm 11.02"
WIDTH DIAMETER	20cm 7.87"
LENGTH PROJECTION	n/a
WEIGHT	2.53KG 5.58lbs
LAMP HOLDER	E27 or E26 *
MAX WATTAGE	6.5W x 1
VOLTAGE	220/240v or 110/120v *
IP RATING	65
CLASS PROTECTION	II
SHADE CODE	GL129 GLWP01
CABLE CHAIN BAR LENGT	100cm 40"
CABLE TYPE	MLOCA002 2 Core Round Black Braid Rubber

Fixing Bracket MLROSE31 | Antique Silver

* Fixing bracket may differ for UL wired products.

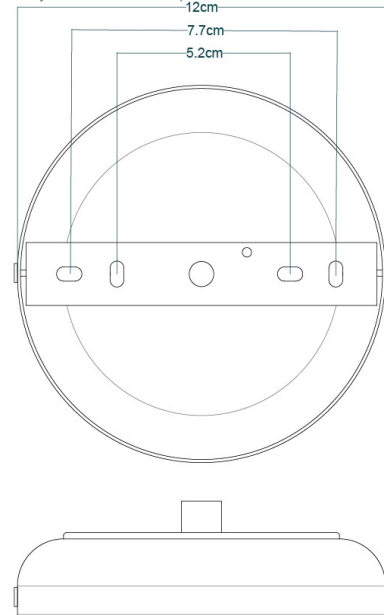

Product Notes:

1) Bulbs not included. 2) Dimensions do not include bulbs. 3) All products are individually made-to-order and therefore may differ slightly within manufacturing tolerances. 4) Cable / chain can be shortened during installation. Longer cable / chain lengths available on request. 5) Additional colour finishes may be available on request. 6) UL wired products operate at 110/120v with the appropriate lamp holder. 7) Twisted cable is not available for UL wired products. Round cable in black or brown only is supplied instead. 8) Refer to our website for a full list of terms and conditions.

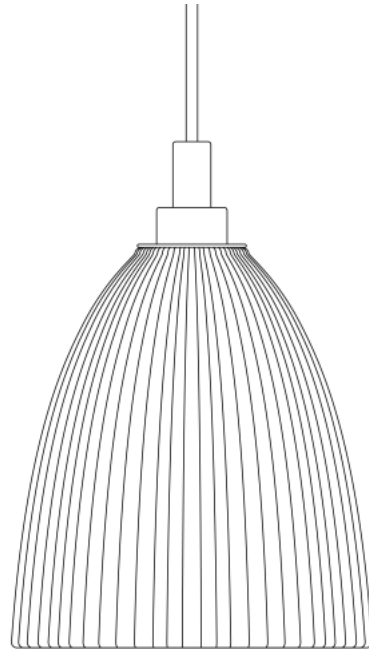

MATERIAL	Brass Glass
HEIGHT	28cm 11.02"
WIDTH DIAMETER	20cm 7.87"
LENGTH PROJECTION	n/a
WEIGHT	2.53KG 5.58lbs
LAMP HOLDER	E27 or E26 *
MAX WATTAGE	6.5W x 1
VOLTAGE	220/240v or 110/120v *
IP RATING	65
CLASS PROTECTION	II
SHADE CODE	GL129 GLWP02
CABLE CHAIN BAR LENGT	100cm 40"
CABLE TYPE	MLOCA002 2 Core Round Black Braid Rubber

Fixing Bracket MLROSE31 | Antique Silver

* Fixing bracket may differ for UL wired products.

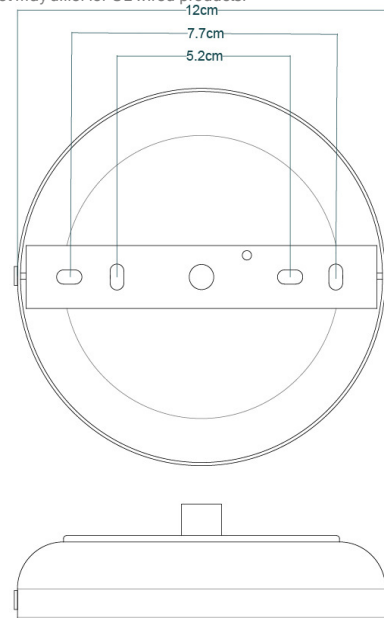

Product Notes:

1) Bulbs not included. 2) Dimensions do not include bulbs. 3) All products are individually made-to-order and therefore may differ slightly within manufacturing tolerances. 4) Cable / chain can be shortened during installation. Longer cable / chain lengths available on request. 5) Additional colour finishes may be available on request. 6) UL wired products operate at 110/120v with the appropriate lamp holder. 7) Twisted cable is not available for UL wired products. Round cable in black or brown only is supplied instead. 8) Refer to our website for a full list of terms and conditions.

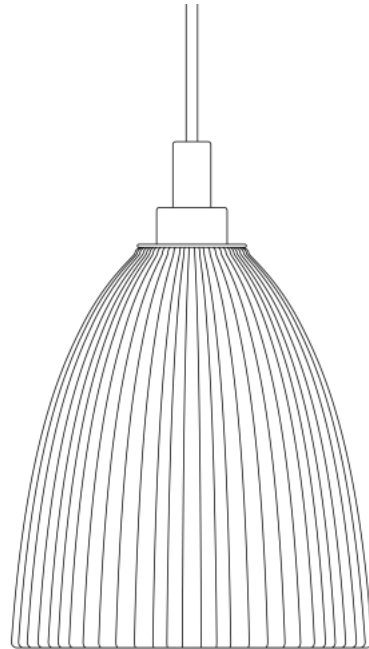

MATERIAL	Brass Glass
HEIGHT	28cm 11.02"
WIDTH DIAMETER	20cm 7.87"
LENGTH PROJECTION	n/a
WEIGHT	2.53KG 5.58lbs
LAMP HOLDER	E27 or E26 *
MAX WATTAGE	6.5W x 1
VOLTAGE	220/240v or 110/120v *
IP RATING	65
CLASS PROTECTION	II
SHADE CODE	GL129 GLWP01
CABLE CHAIN BAR LENGT	100cm 40"
CABLE TYPE	MLOCA002 2 Core Round Black Braid Rubber

Fixing Bracket MLROSE31 | Natural Brass

* Fixing bracket may differ for UL wired products.

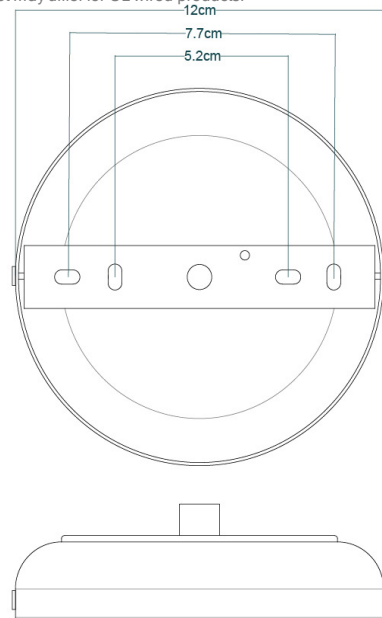

Product Notes:

1) Bulbs not included. 2) Dimensions do not include bulbs. 3) All products are individually made-to-order and therefore may differ slightly within manufacturing tolerances. 4) Cable / chain can be shortened during installation. Longer cable / chain lengths available on request. 5) Additional colour finishes may be available on request. 6) UL wired products operate at 110/120v with the appropriate lamp holder. 7) Twisted cable is not available for UL wired products. Round cable in black or brown only is supplied instead. 8) Refer to our website for a full list of terms and conditions.

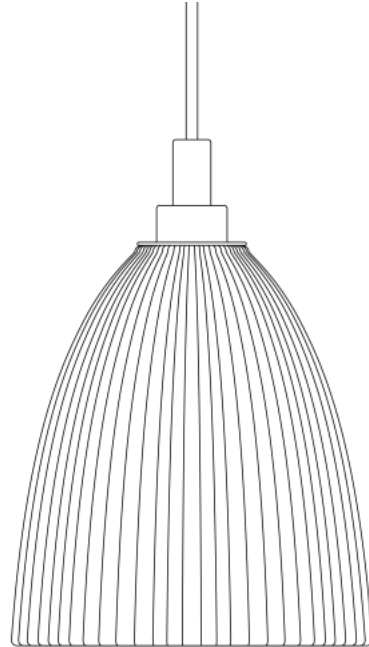

MATERIAL	Brass Glass
HEIGHT	28cm 11.02"
WIDTH DIAMETER	20cm 7.87"
LENGTH PROJECTION	n/a
WEIGHT	2.53KG 5.58lbs
LAMP HOLDER	E27 or E26 *
MAX WATTAGE	6.5W x 1
VOLTAGE	220/240v or 110/120v *
IP RATING	65
CLASS PROTECTION	II
SHADE CODE	GL129 GLWP02
CABLE CHAIN BAR LENGT	100cm 40"
CABLE TYPE	MLOCA002 2 Core Round Black Braid Rubber

Fixing Bracket MLROSE31 | Natural Brass

* Fixing bracket may differ for UL wired products.

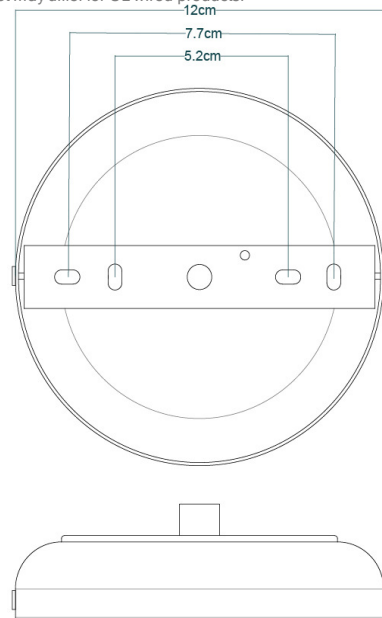

Product Notes:

1) Bulbs not included. 2) Dimensions do not include bulbs. 3) All products are individually made-to-order and therefore may differ slightly within manufacturing tolerances. 4) Cable / chain can be shortened during installation. Longer cable / chain lengths available on request. 5) Additional colour finishes may be available on request. 6) UL wired products operate at 110/120v with the appropriate lamp holder. 7) Twisted cable is not available for UL wired products. Round cable in black or brown only is supplied instead. 8) Refer to our website for a full list of terms and conditions.

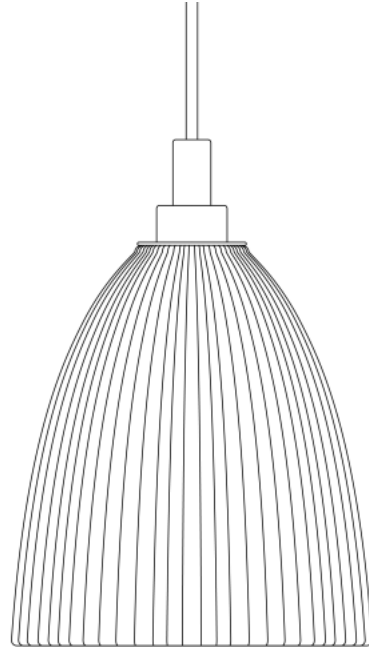

MATERIAL	Brass Glass
HEIGHT	28cm 11.02"
WIDTH DIAMETER	20cm 7.87"
LENGTH PROJECTION	n/a
WEIGHT	2.53KG 5.58lbs
LAMP HOLDER	E27 or E26 *
MAX WATTAGE	6.5W x 1
VOLTAGE	220/240v or 110/120v *
IP RATING	65
CLASS PROTECTION	II
SHADE CODE	GL129 GLWP01
CABLE CHAIN BAR LENGT	100cm 40"
CABLE TYPE	MLOCA002 2 Core Round Black Braid Rubber

Fixing Bracket MLROSE31 | Matt Black

* Fixing bracket may differ for UL wired products.

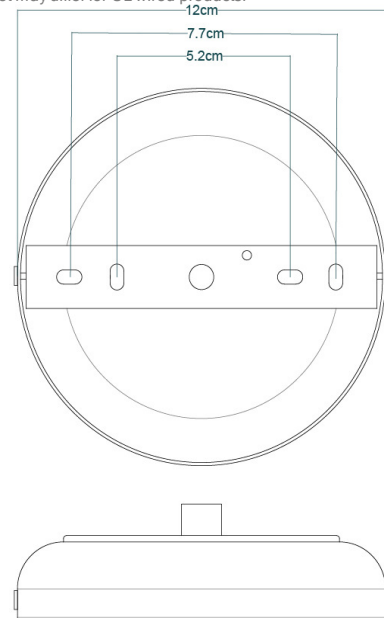

Product Notes:

1) Bulbs not included. 2) Dimensions do not include bulbs. 3) All products are individually made-to-order and therefore may differ slightly within manufacturing tolerances. 4) Cable / chain can be shortened during installation. Longer cable / chain lengths available on request. 5) Additional colour finishes may be available on request. 6) UL wired products operate at 110/120v with the appropriate lamp holder. 7) Twisted cable is not available for UL wired products. Round cable in black or brown only is supplied instead. 8) Refer to our website for a full list of terms and conditions.

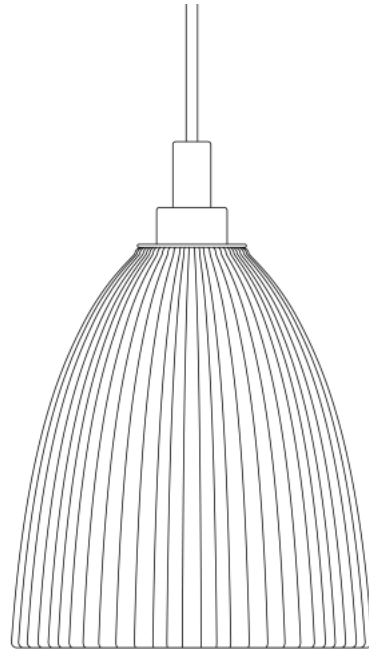

MATERIAL	Brass Glass
HEIGHT	28cm 11.02"
WIDTH DIAMETER	20cm 7.87"
LENGTH PROJECTION	n/a
WEIGHT	2.53KG 5.58lbs
LAMP HOLDER	E27 or E26 *
MAX WATTAGE	6.5W x 1
VOLTAGE	220/240v or 110/120v *
IP RATING	65
CLASS PROTECTION	II
SHADE CODE	GL129 GLWP02
CABLE CHAIN BAR LENGT	100cm 40"
CABLE TYPE	MLOCA002 2 Core Round Black Braid Rubber

Fixing Bracket MLROSE31 | Matt Black

* Fixing bracket may differ for UL wired products.

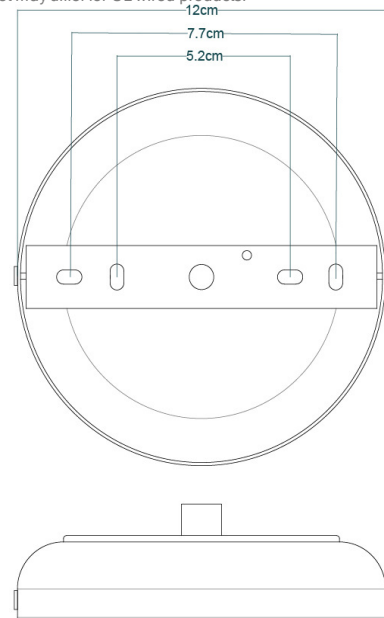

Product Notes:

1) Bulbs not included. 2) Dimensions do not include bulbs. 3) All products are individually made-to-order and therefore may differ slightly within manufacturing tolerances. 4) Cable / chain can be shortened during installation. Longer cable / chain lengths available on request. 5) Additional colour finishes may be available on request. 6) UL wired products operate at 110/120v with the appropriate lamp holder. 7) Twisted cable is not available for UL wired products. Round cable in black or brown only is supplied instead. 8) Refer to our website for a full list of terms and conditions.

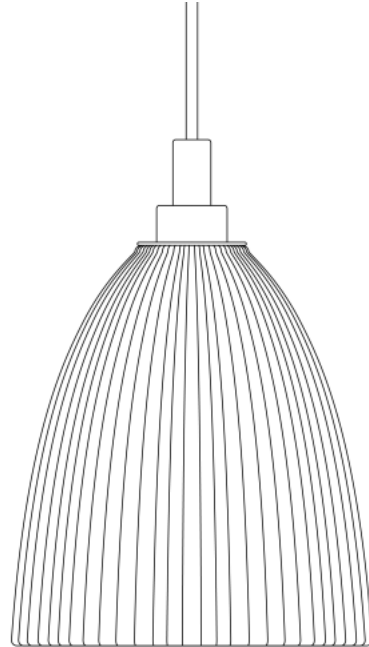

MATERIAL	Brass Glass
HEIGHT	28cm 11.02"
WIDTH DIAMETER	20cm 7.87"
LENGTH PROJECTION	n/a
WEIGHT	2.53KG 5.58lbs
LAMP HOLDER	E27 or E26 *
MAX WATTAGE	6.5W x 1
VOLTAGE	220/240v or 110/120v *
IP RATING	65
CLASS PROTECTION	II
SHADE CODE	GL129 GLWP01
CABLE CHAIN BAR LENGT	100cm 40"
CABLE TYPE	MLOCA002 2 Core Round Black Braid Rubber

Fixing Bracket MLROSE31 | White

* Fixing bracket may differ for UL wired products.

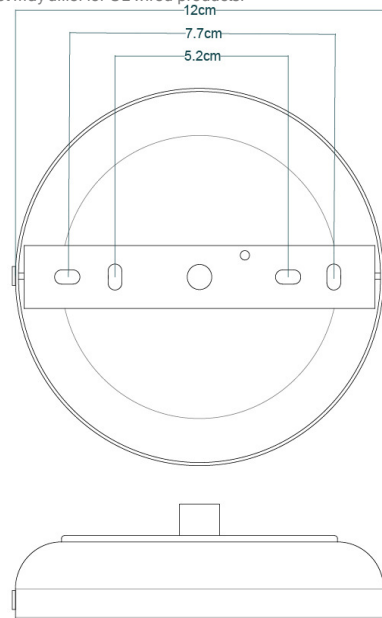

Product Notes:

1) Bulbs not included. 2) Dimensions do not include bulbs. 3) All products are individually made-to-order and therefore may differ slightly within manufacturing tolerances. 4) Cable / chain can be shortened during installation. Longer cable / chain lengths available on request. 5) Additional colour finishes may be available on request. 6) UL wired products operate at 110/120v with the appropriate lamp holder. 7) Twisted cable is not available for UL wired products. Round cable in black or brown only is supplied instead. 8) Refer to our website for a full list of terms and conditions.

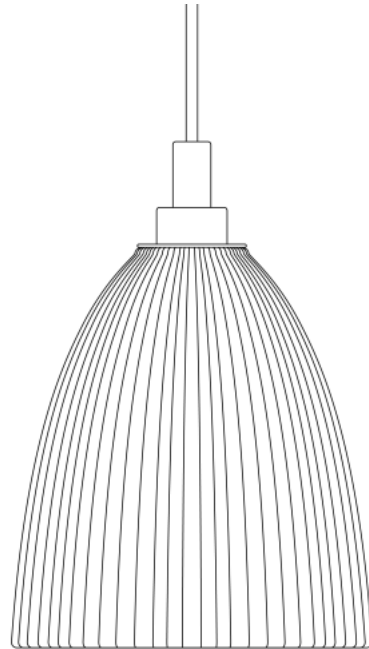

MATERIAL	Brass Glass
HEIGHT	28cm 11.02"
WIDTH DIAMETER	20cm 7.87"
LENGTH PROJECTION	n/a
WEIGHT	2.53KG 5.58lbs
LAMP HOLDER	E27 or E26 *
MAX WATTAGE	6.5W x 1
VOLTAGE	220/240v or 110/120v *
IP RATING	65
CLASS PROTECTION	II
SHADE CODE	GL129 GLWP02
CABLE CHAIN BAR LENGT	100cm 40"
CABLE TYPE	MLOCA002 2 Core Round Black Braid Rubber

Fixing Bracket MLROSE31 | White

* Fixing bracket may differ for UL wired products.

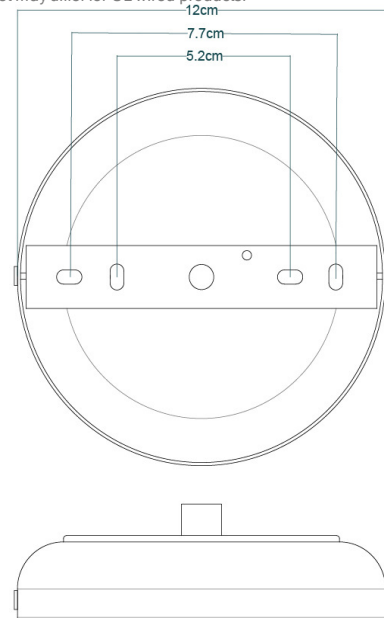

Product Notes:

1) Bulbs not included. 2) Dimensions do not include bulbs. 3) All products are individually made-to-order and therefore may differ slightly within manufacturing tolerances. 4) Cable / chain can be shortened during installation. Longer cable / chain lengths available on request. 5) Additional colour finishes may be available on request. 6) UL wired products operate at 110/120v with the appropriate lamp holder. 7) Twisted cable is not available for UL wired products. Round cable in black or brown only is supplied instead. 8) Refer to our website for a full list of terms and conditions.

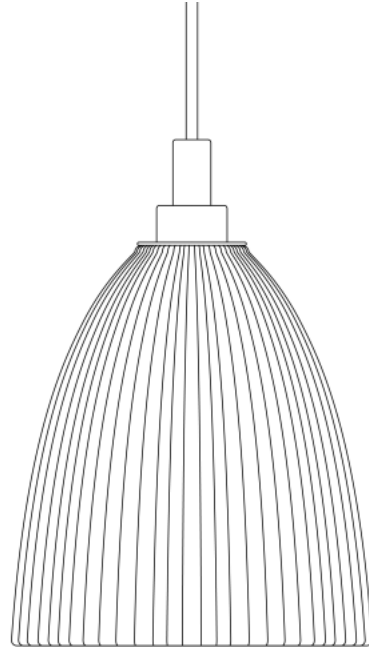

MATERIAL	Brass Glass
HEIGHT	28cm 11.02"
WIDTH DIAMETER	20cm 7.87"
LENGTH PROJECTION	n/a
WEIGHT	2.53KG 5.58lbs
LAMP HOLDER	E27 or E26 *
MAX WATTAGE	6.5W x 1
VOLTAGE	220/240v or 110/120v *
IP RATING	65
CLASS PROTECTION	II
SHADE CODE	GL129 GLWP01
CABLE CHAIN BAR LENGT	100cm 40"
CABLE TYPE	MLOCA002 2 Core Round Black Braid Rubber

Fixing Bracket MLROSE31 | Polished Brass

* Fixing bracket may differ for UL wired products.

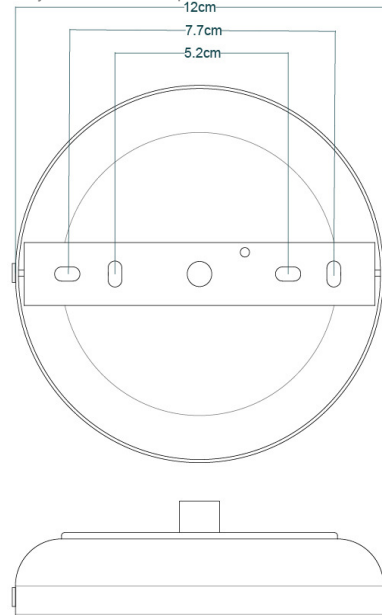

Product Notes:

1) Bulbs not included. 2) Dimensions do not include bulbs. 3) All products are individually made-to-order and therefore may differ slightly within manufacturing tolerances. 4) Cable / chain can be shortened during installation. Longer cable / chain lengths available on request. 5) Additional colour finishes may be available on request. 6) UL wired products operate at 110/120v with the appropriate lamp holder. 7) Twisted cable is not available for UL wired products. Round cable in black or brown only is supplied instead. 8) Refer to our website for a full list of terms and conditions.

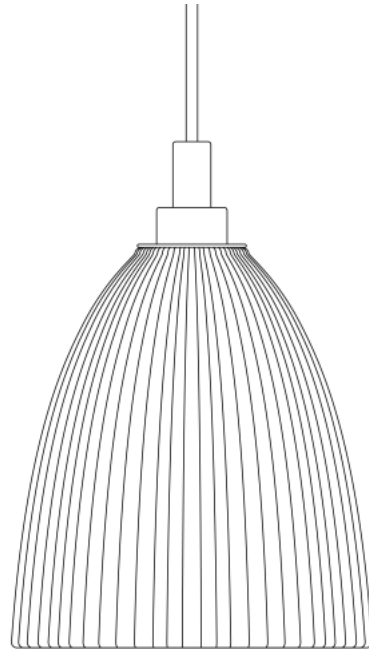

MATERIAL	Brass Glass
HEIGHT	28cm 11.02"
WIDTH DIAMETER	20cm 7.87"
LENGTH PROJECTION	n/a
WEIGHT	2.53KG 5.58lbs
LAMP HOLDER	E27 or E26 *
MAX WATTAGE	6.5W x 1
VOLTAGE	220/240v or 110/120v *
IP RATING	65
CLASS PROTECTION	II
SHADE CODE	GL129 GLWP02
CABLE CHAIN BAR LENGT	100cm 40"
CABLE TYPE	MLOCA002 2 Core Round Black Braid Rubber

Fixing Bracket MLROSE31 | Polished Brass

* Fixing bracket may differ for UL wired products.

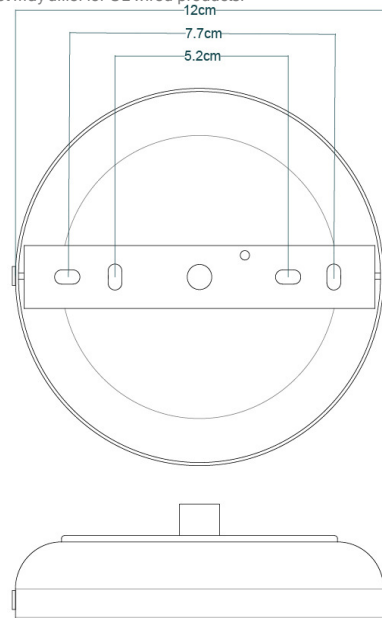

Product Notes:

1) Bulbs not included. 2) Dimensions do not include bulbs. 3) All products are individually made-to-order and therefore may differ slightly within manufacturing tolerances. 4) Cable / chain can be shortened during installation. Longer cable / chain lengths available on request. 5) Additional colour finishes may be available on request. 6) UL wired products operate at 110/120v with the appropriate lamp holder. 7) Twisted cable is not available for UL wired products. Round cable in black or brown only is supplied instead. 8) Refer to our website for a full list of terms and conditions.

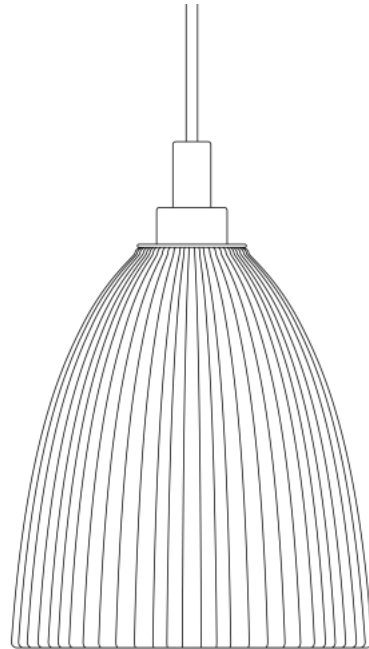

MATERIAL	Brass Glass
HEIGHT	28cm 11.02"
WIDTH DIAMETER	20cm 7.87"
LENGTH PROJECTION	n/a
WEIGHT	2.53KG 5.58lbs
LAMP HOLDER	E27 or E26 *
MAX WATTAGE	6.5W x 1
VOLTAGE	220/240v or 110/120v *
IP RATING	65
CLASS PROTECTION	II
SHADE CODE	GL129 GLWP01
CABLE CHAIN BAR LENGT	100cm 40"
CABLE TYPE	MLOCA002 2 Core Round Black Braid Rubber

Fixing Bracket MLROSE31 | Polished Chrome

* Fixing bracket may differ for UL wired products.

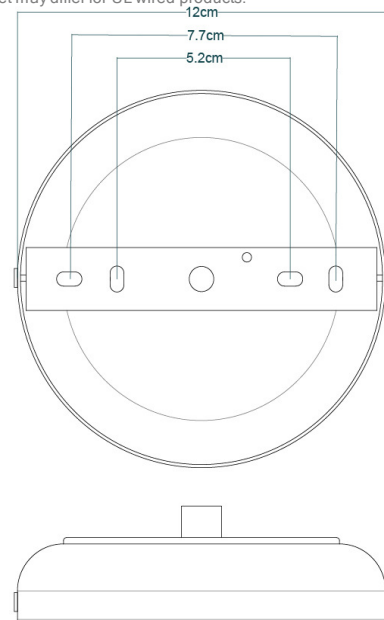
Product Notes:

1) Bulbs not included. 2) Dimensions do not include bulbs. 3) All products are individually made-to-order and therefore may differ slightly within manufacturing tolerances. 4) Cable / chain can be shortened during installation. Longer cable / chain lengths available on request. 5) Additional colour finishes may be available on request. 6) UL wired products operate at 110/120v with the appropriate lamp holder. 7) Twisted cable is not available for UL wired products. Round cable in black or brown only is supplied instead. 8) Refer to our website for a full list of terms and conditions.

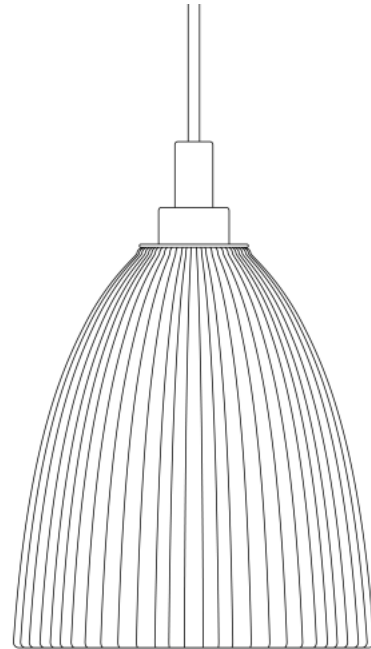

MATERIAL	Brass Glass
HEIGHT	28cm 11.02"
WIDTH DIAMETER	20cm 7.87"
LENGTH PROJECTION	n/a
WEIGHT	2.53KG 5.58lbs
LAMP HOLDER	E27 or E26 *
MAX WATTAGE	6.5W x 1
VOLTAGE	220/240v or 110/120v *
IP RATING	65
CLASS PROTECTION	II
SHADE CODE	GL129 GLWP02
CABLE CHAIN BAR LENGT	100cm 40"
CABLE TYPE	MLOCA002 2 Core Round Black Braid Rubber

Fixing Bracket MLROSE31 | Polished Chrome

* Fixing bracket may differ for UL wired products.

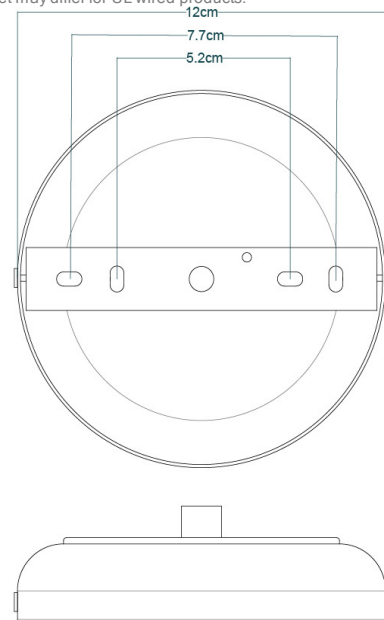
Product Notes:

1) Bulbs not included. 2) Dimensions do not include bulbs. 3) All products are individually made-to-order and therefore may differ slightly within manufacturing tolerances. 4) Cable / chain can be shortened during installation. Longer cable / chain lengths available on request. 5) Additional colour finishes may be available on request. 6) UL wired products operate at 110/120v with the appropriate lamp holder. 7) Twisted cable is not available for UL wired products. Round cable in black or brown only is supplied instead. 8) Refer to our website for a full list of terms and conditions.

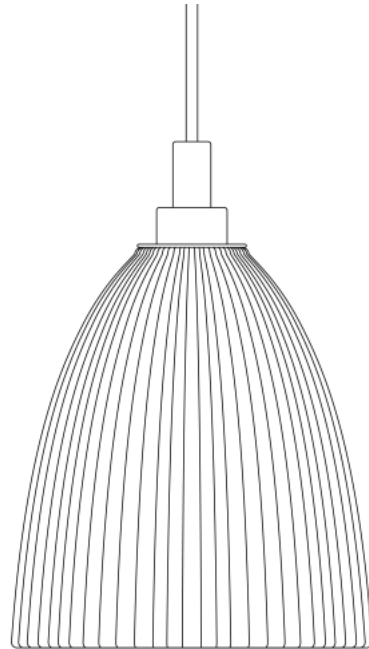

MATERIAL	Brass Glass
HEIGHT	28cm 11.02"
WIDTH DIAMETER	20cm 7.87"
LENGTH PROJECTION	n/a
WEIGHT	2.53KG 5.58lbs
LAMP HOLDER	E27 or E26 *
MAX WATTAGE	6.5W x 1
VOLTAGE	220/240v or 110/120v *
IP RATING	65
CLASS PROTECTION	II
SHADE CODE	GL129 GLWP01
CABLE CHAIN BAR LENGT	100cm 40"
CABLE TYPE	MLOCA002 2 Core Round Black Braid Rubber

Fixing Bracket MLROSE31 | Satin Brass

* Fixing bracket may differ for UL wired products.

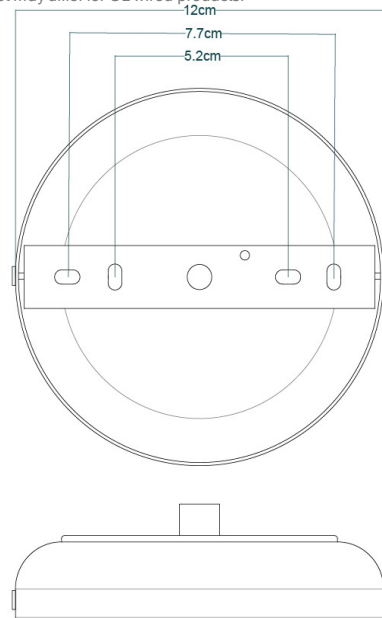

Product Notes:

1) Bulbs not included. 2) Dimensions do not include bulbs. 3) All products are individually made-to-order and therefore may differ slightly within manufacturing tolerances. 4) Cable / chain can be shortened during installation. Longer cable / chain lengths available on request. 5) Additional colour finishes may be available on request. 6) UL wired products operate at 110/120v with the appropriate lamp holder. 7) Twisted cable is not available for UL wired products. Round cable in black or brown only is supplied instead. 8) Refer to our website for a full list of terms and conditions.

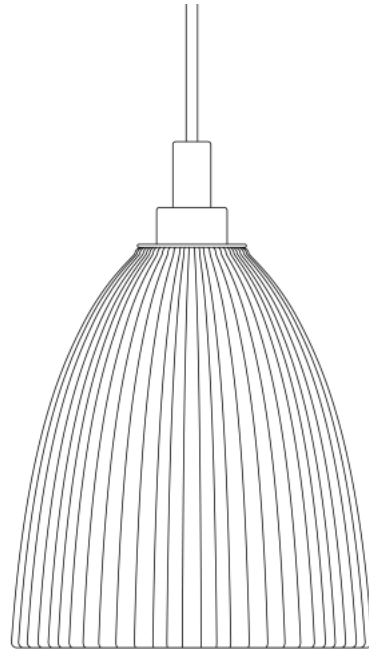

MATERIAL	Brass Glass
HEIGHT	28cm 11.02"
WIDTH DIAMETER	20cm 7.87"
LENGTH PROJECTION	n/a
WEIGHT	2.53KG 5.58lbs
LAMP HOLDER	E27 or E26 *
MAX WATTAGE	6.5W x 1
VOLTAGE	220/240v or 110/120v *
IP RATING	65
CLASS PROTECTION	II
SHADE CODE	GL129 GLWP02
CABLE CHAIN BAR LENGT	100cm 40"
CABLE TYPE	MLOCA002 2 Core Round Black Braid Rubber

Fixing Bracket MLROSE31 | Satin Brass

* Fixing bracket may differ for UL wired products.

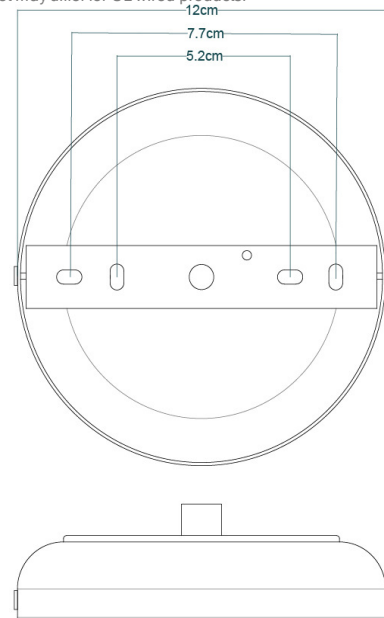

Product Notes:

1) Bulbs not included. 2) Dimensions do not include bulbs. 3) All products are individually made-to-order and therefore may differ slightly within manufacturing tolerances. 4) Cable / chain can be shortened during installation. Longer cable / chain lengths available on request. 5) Additional colour finishes may be available on request. 6) UL wired products operate at 110/120v with the appropriate lamp holder. 7) Twisted cable is not available for UL wired products. Round cable in black or brown only is supplied instead. 8) Refer to our website for a full list of terms and conditions.