

MATERIAL	Brass Glass
HEIGHT	33cm 12.99"
WIDTH DIAMETER	18cm 7.09"
LENGTH PROJECTION	36cm 14.17"
WEIGHT	1.27KG 2.8lbs
LAMPHOLDER	E27 x 1
MAX WATTAGE	6.5W x 1
VOLTAGE	220/240v
IP RATING	65
CLASS PROTECTION	II
SHADE	GL146 GLWP01
FLEX BAR CHAIN LENGT	n/a
CABLE TYPE	-

Fixing Bracket MLWB17 | Antique Brass

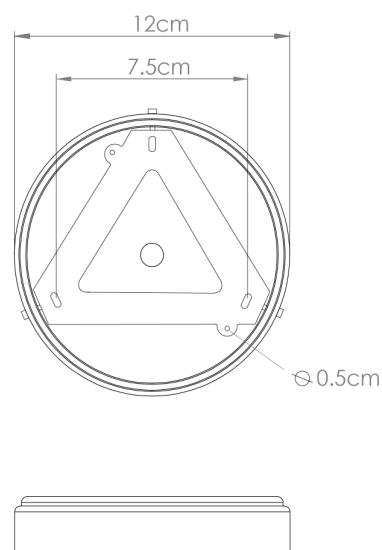

Product Notes:

1) Lamps not included with light fixture. 2) All products are individually hand crafted, therefore may differ slightly within manufacturing tolerances. 3) Please refer to: <http://www.mullanlighting.com/terms> for full list of Terms & Conditions. 4) Cable/Chain can be shortened during installation. 5) Longer Cable/Chain available on request. 6) Additional colour finishes available on request. 7.) Dimensions do not include lamps. 8.) Products wired to UL standards will operate at 110/120v with the appropriate lampholders.

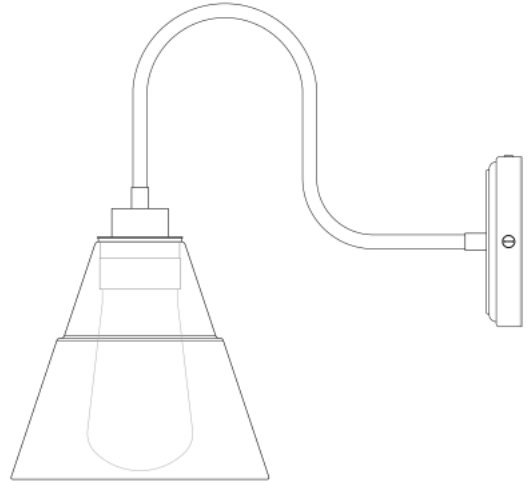

MATERIAL	Brass Glass
HEIGHT	33cm 12.99"
WIDTH DIAMETER	18cm 7.09"
LENGTH PROJECTION	36cm 14.17"
WEIGHT	1.27KG 2.8lbs
LAMPHOLDER	E27 x 1
MAX WATTAGE	6.5W x 1
VOLTAGE	220/240v
IP RATING	65
CLASS PROTECTION	II
SHADE	GL146 GLWP02
FLEX BAR CHAIN LENGT	n/a
CABLE TYPE	-

Fixing Bracket MLWB17 | Antique Brass

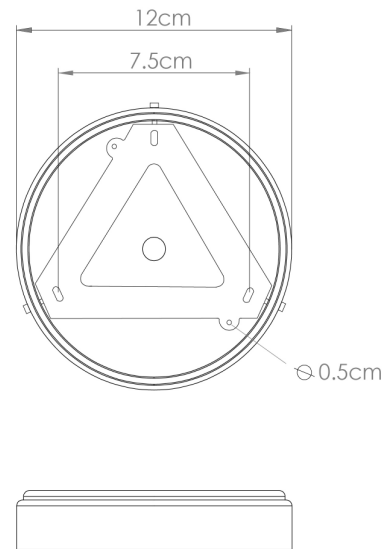

Product Notes:

1) Lamps not included with light fixture. 2) All products are individually hand crafted, therefore may differ slightly within manufacturing tolerances. 3) Please refer to: <http://www.mullanlighting.com/terms> for full list of Terms & Conditions. 4) Cable/Chain can be shortened during installation. 5) Longer Cable/Chain available on request. 6) Additional colour finishes available on request. 7.) Dimensions do not include lamps. 8.) Products wired to UL standards will operate at 110/120v with the appropriate lampholders.



MATERIAL	Brass Glass
HEIGHT	33cm 12.99"
WIDTH DIAMETER	18cm 7.09"
LENGTH PROJECTION	36cm 14.17"
WEIGHT	1.27KG 2.8lbs
LAMPHOLDER	E27 x 1
MAX WATTAGE	6.5W x 1
VOLTAGE	220/240v
IP RATING	65
CLASS PROTECTION	II
SHADE	GL146 GLWP01
FLEX BAR CHAIN LENGT	n/a
CABLE TYPE	-

Fixing Bracket MLWB17 | Antique Silver

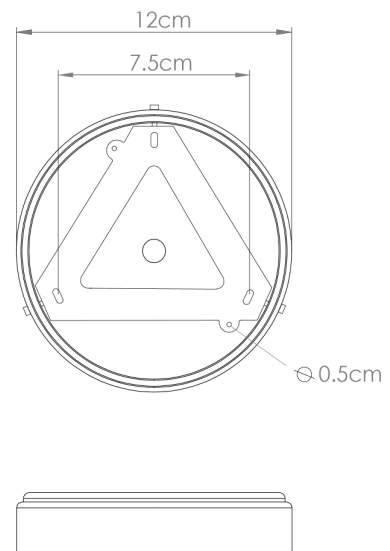

Product Notes:

1) Lamps not included with light fixture. 2) All products are individually hand crafted, therefore may differ slightly within manufacturing tolerances. 3) Please refer to: <http://www.mullanlighting.com/terms> for full list of Terms & Conditions. 4) Cable/Chain can be shortened during installation. 5) Longer Cable/Chain available on request. 6) Additional colour finishes available on request. 7.) Dimensions do not include lamps. 8.) Products wired to UL standards will operate at 110/120v with the appropriate lampholders.

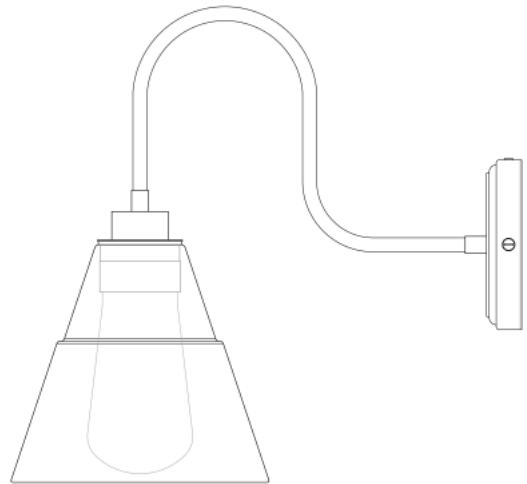

MATERIAL	Brass Glass
HEIGHT	33cm 12.99"
WIDTH DIAMETER	18cm 7.09"
LENGTH PROJECTION	36cm 14.17"
WEIGHT	1.27KG 2.8lbs
LAMPHOLDER	E27 x 1
MAX WATTAGE	6.5W x 1
VOLTAGE	220/240v
IP RATING	65
CLASS PROTECTION	II
SHADE	GL146 GLWP02
FLEX BAR CHAIN LENGT	n/a
CABLE TYPE	-

Fixing Bracket MLWB17 | Antique Silver

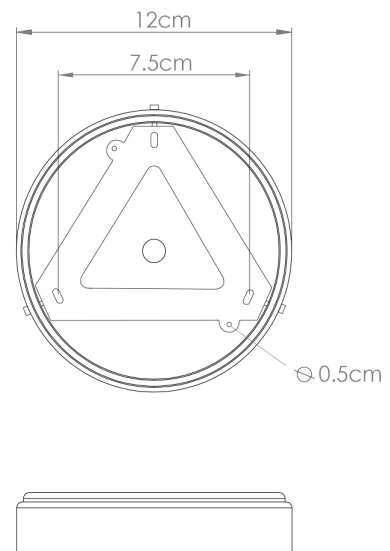

Product Notes:

1) Lamps not included with light fixture. 2) All products are individually hand crafted, therefore may differ slightly within manufacturing tolerances. 3) Please refer to: <http://www.mullanlighting.com/terms> for full list of Terms & Conditions. 4) Cable/Chain can be shortened during installation. 5) Longer Cable/Chain available on request. 6) Additional colour finishes available on request. 7.) Dimensions do not include lamps. 8.) Products wired to UL standards will operate at 110/120v with the appropriate lampholders.

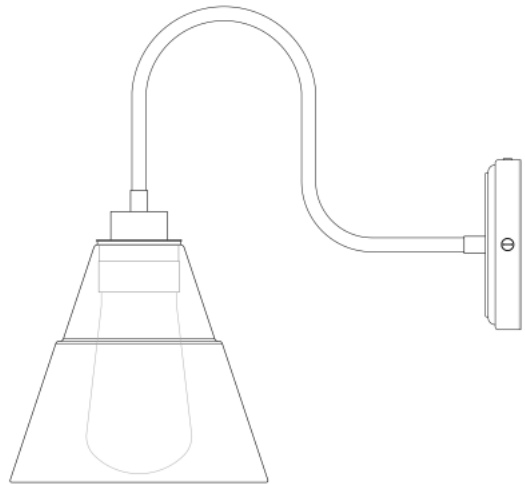

MATERIAL	Brass Glass
HEIGHT	33cm 12.99"
WIDTH DIAMETER	18cm 7.09"
LENGTH PROJECTION	36cm 14.17"
WEIGHT	1.27KG 2.8lbs
LAMPHOLDER	E27 x 1
MAX WATTAGE	6.5W x 1
VOLTAGE	220/240v
IP RATING	65
CLASS PROTECTION	II
SHADE	GL146 GLWP01
FLEX BAR CHAIN LENGT	n/a
CABLE TYPE	-

Fixing Bracket MLWB17 | Natural Brass

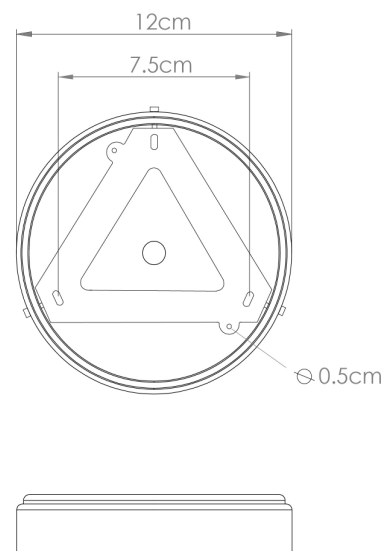

Product Notes:

1) Lamps not included with light fixture. 2) All products are individually hand crafted, therefore may differ slightly within manufacturing tolerances. 3) Please refer to: <http://www.mullanlighting.com/terms> for full list of Terms & Conditions. 4) Cable/Chain can be shortened during installation. 5) Longer Cable/Chain available on request. 6) Additional colour finishes available on request. 7.) Dimensions do not include lamps. 8.) Products wired to UL standards will operate at 110/120v with the appropriate lampholders.

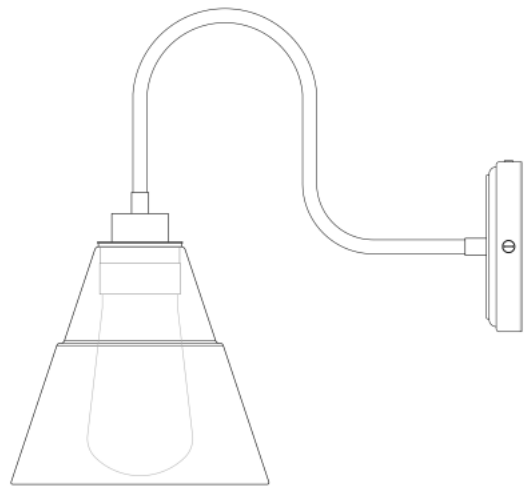

MATERIAL	Brass Glass
HEIGHT	33cm 12.99"
WIDTH DIAMETER	18cm 7.09"
LENGTH PROJECTION	36cm 14.17"
WEIGHT	1.27KG 2.8lbs
LAMPHOLDER	E27 x 1
MAX WATTAGE	6.5W x 1
VOLTAGE	220/240v
IP RATING	65
CLASS PROTECTION	II
SHADE	GL146 GLWP02
FLEX BAR CHAIN LENGT	n/a
CABLE TYPE	-

Fixing Bracket MLWB17 | Natural Brass

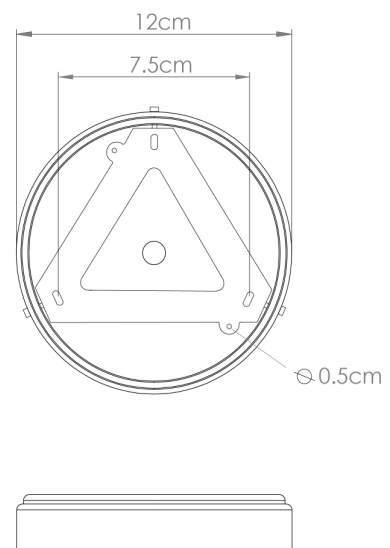

Product Notes:

1) Lamps not included with light fixture. 2) All products are individually hand crafted, therefore may differ slightly within manufacturing tolerances. 3) Please refer to: <http://www.mullanlighting.com/terms> for full list of Terms & Conditions. 4) Cable/Chain can be shortened during installation. 5) Longer Cable/Chain available on request. 6) Additional colour finishes available on request. 7.) Dimensions do not include lamps. 8.) Products wired to UL standards will operate at 110/120v with the appropriate lampholders.

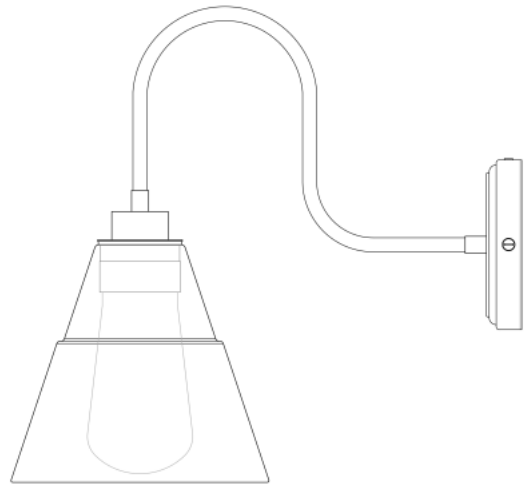

MATERIAL	Brass Glass
HEIGHT	33cm 12.99"
WIDTH DIAMETER	18cm 7.09"
LENGTH PROJECTION	36cm 14.17"
WEIGHT	1.27KG 2.8lbs
LAMPHOLDER	E27 x 1
MAX WATTAGE	6.5W x 1
VOLTAGE	220/240v
IP RATING	65
CLASS PROTECTION	II
SHADE	GL146 GLWP01
FLEX BAR CHAIN LENGT	n/a
CABLE TYPE	-

Fixing Bracket MLWB17 | Matt Black

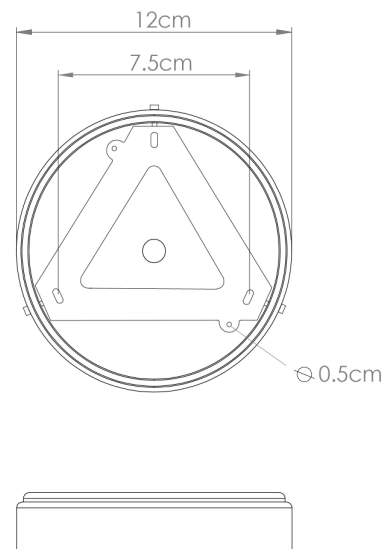

Product Notes:

1) Lamps not included with light fixture. 2) All products are individually hand crafted, therefore may differ slightly within manufacturing tolerances. 3) Please refer to: <http://www.mullanlighting.com/terms> for full list of Terms & Conditions. 4) Cable/Chain can be shortened during installation. 5) Longer Cable/Chain available on request. 6) Additional colour finishes available on request. 7.) Dimensions do not include lamps. 8.) Products wired to UL standards will operate at 110/120v with the appropriate lampholders.

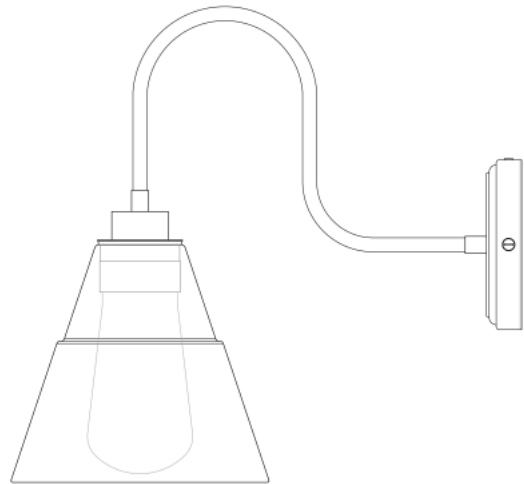

MATERIAL	Brass Glass
HEIGHT	33cm 12.99"
WIDTH DIAMETER	18cm 7.09"
LENGTH PROJECTION	36cm 14.17"
WEIGHT	1.27KG 2.8lbs
LAMPHOLDER	E27 x 1
MAX WATTAGE	6.5W x 1
VOLTAGE	220/240v
IP RATING	65
CLASS PROTECTION	II
SHADE	GL146 GLWP02
FLEX BAR CHAIN LENGT	n/a
CABLE TYPE	-

Fixing Bracket MLWB17 | Matt Black

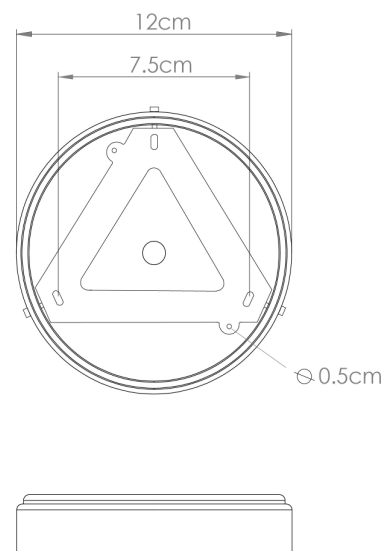

Product Notes:

1) Lamps not included with light fixture. 2) All products are individually hand crafted, therefore may differ slightly within manufacturing tolerances. 3) Please refer to: <http://www.mullanlighting.com/terms> for full list of Terms & Conditions. 4) Cable/Chain can be shortened during installation. 5) Longer Cable/Chain available on request. 6) Additional colour finishes available on request. 7.) Dimensions do not include lamps. 8.) Products wired to UL standards will operate at 110/120v with the appropriate lampholders.

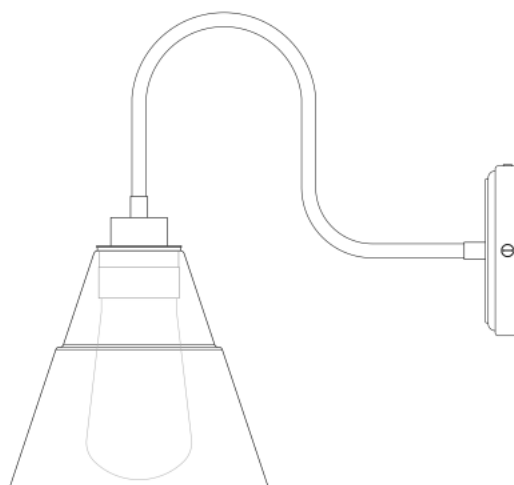

MATERIAL	Brass Glass
HEIGHT	33cm 12.99"
WIDTH DIAMETER	18cm 7.09"
LENGTH PROJECTION	36cm 14.17"
WEIGHT	1.27KG 2.8lbs
LAMPHOLDER	E27 x 1
MAX WATTAGE	6.5W x 1
VOLTAGE	220/240v
IP RATING	65
CLASS PROTECTION	II
SHADE	GL146 GLWP01
FLEX BAR CHAIN LENGT	n/a
CABLE TYPE	-

Fixing Bracket MLWB17 | White

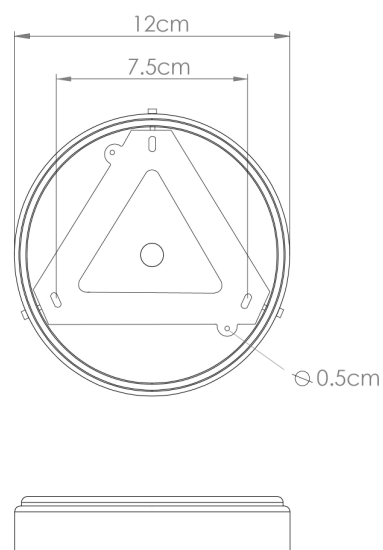

Product Notes:

1) Lamps not included with light fixture. 2) All products are individually hand crafted, therefore may differ slightly within manufacturing tolerances. 3) Please refer to: <http://www.mullanlighting.com/terms> for full list of Terms & Conditions. 4) Cable/Chain can be shortened during installation. 5) Longer Cable/Chain available on request. 6) Additional colour finishes available on request. 7.) Dimensions do not include lamps. 8.) Products wired to UL standards will operate at 110/120v with the appropriate lampholders.

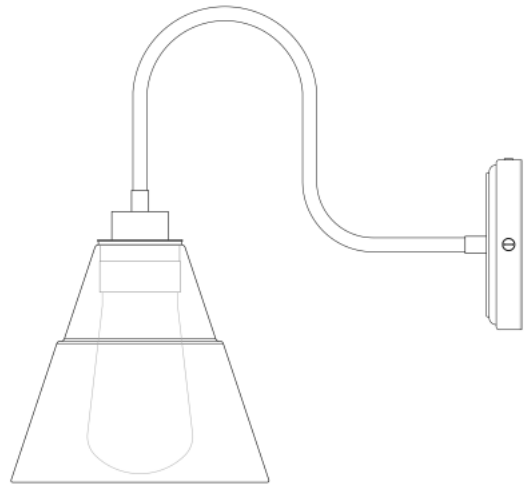

MATERIAL	Brass Glass
HEIGHT	33cm 12.99"
WIDTH DIAMETER	18cm 7.09"
LENGTH PROJECTION	36cm 14.17"
WEIGHT	1.27KG 2.8lbs
LAMPHOLDER	E27 x 1
MAX WATTAGE	6.5W x 1
VOLTAGE	220/240v
IP RATING	65
CLASS PROTECTION	II
SHADE	GL146 GLWP02
FLEX BAR CHAIN LENGT	n/a
CABLE TYPE	-

Fixing Bracket MLWB17 | White

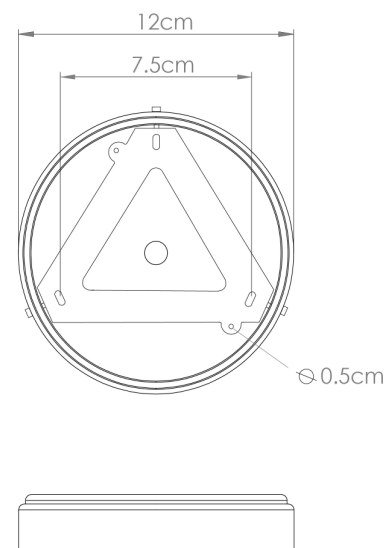

Product Notes:

1) Lamps not included with light fixture. 2) All products are individually hand crafted, therefore may differ slightly within manufacturing tolerances. 3) Please refer to: <http://www.mullanlighting.com/terms> for full list of Terms & Conditions. 4) Cable/Chain can be shortened during installation. 5) Longer Cable/Chain available on request. 6) Additional colour finishes available on request. 7.) Dimensions do not include lamps. 8.) Products wired to UL standards will operate at 110/120v with the appropriate lampholders.



MATERIAL	Brass Glass
HEIGHT	33cm 12.99"
WIDTH DIAMETER	18cm 7.09"
LENGTH PROJECTION	36cm 14.17"
WEIGHT	1.27KG 2.8lbs
LAMPHOLDER	E27 x 1
MAX WATTAGE	6.5W x 1
VOLTAGE	220/240v
IP RATING	65
CLASS PROTECTION	II
SHADE	GL146 GLWP01
FLEX BAR CHAIN LENGT	n/a
CABLE TYPE	-

Fixing Bracket MLWB17 | Polished Brass

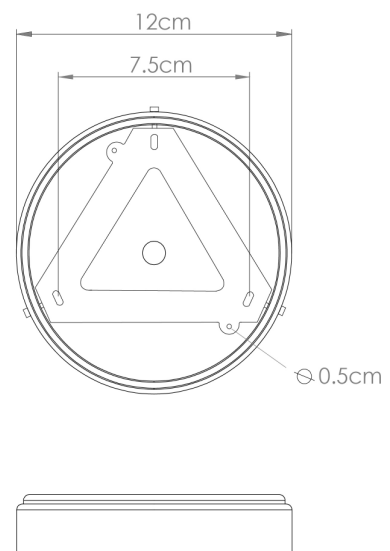

Product Notes:

1) Lamps not included with light fixture. 2) All products are individually hand crafted, therefore may differ slightly within manufacturing tolerances. 3) Please refer to: <http://www.mullanlighting.com/terms> for full list of Terms & Conditions. 4) Cable/Chain can be shortened during installation. 5) Longer Cable/Chain available on request. 6) Additional colour finishes available on request. 7.) Dimensions do not include lamps. 8.) Products wired to UL standards will operate at 110/120v with the appropriate lampholders.

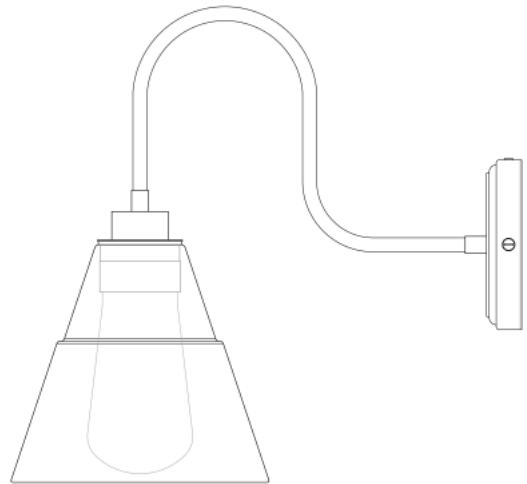

MATERIAL	Brass Glass
HEIGHT	33cm 12.99"
WIDTH DIAMETER	18cm 7.09"
LENGTH PROJECTION	36cm 14.17"
WEIGHT	1.27KG 2.8lbs
LAMPHOLDER	E27 x 1
MAX WATTAGE	6.5W x 1
VOLTAGE	220/240v
IP RATING	65
CLASS PROTECTION	II
SHADE	GL146 GLWP02
FLEX BAR CHAIN LENGT	n/a
CABLE TYPE	-

Fixing Bracket MLWB17 | Polished Brass

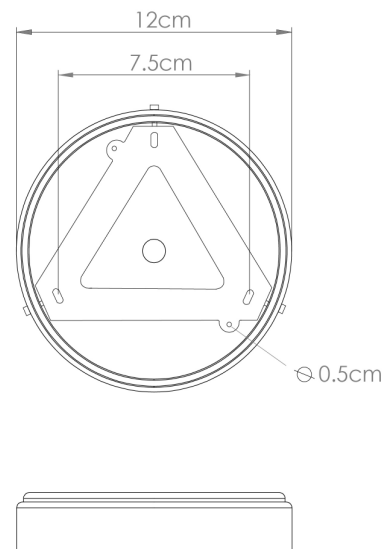

Product Notes:

1) Lamps not included with light fixture. 2) All products are individually hand crafted, therefore may differ slightly within manufacturing tolerances. 3) Please refer to: <http://www.mullanlighting.com/terms> for full list of Terms & Conditions. 4) Cable/Chain can be shortened during installation. 5) Longer Cable/Chain available on request. 6) Additional colour finishes available on request. 7.) Dimensions do not include lamps. 8.) Products wired to UL standards will operate at 110/120v with the appropriate lampholders.

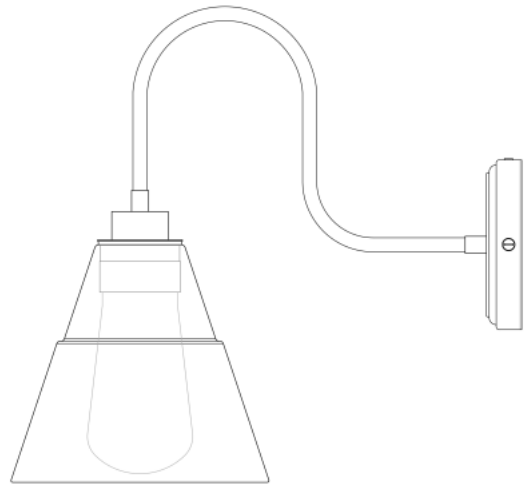

MATERIAL	Brass Glass
HEIGHT	33cm 12.99"
WIDTH DIAMETER	18cm 7.09"
LENGTH PROJECTION	36cm 14.17"
WEIGHT	1.27KG 2.8lbs
LAMPHOLDER	E27 x 1
MAX WATTAGE	6.5W x 1
VOLTAGE	220/240v
IP RATING	65
CLASS PROTECTION	II
SHADE	GL146 GLWP01
FLEX BAR CHAIN LENGT	n/a
CABLE TYPE	-

Fixing Bracket MLWB17 | Satin Brass

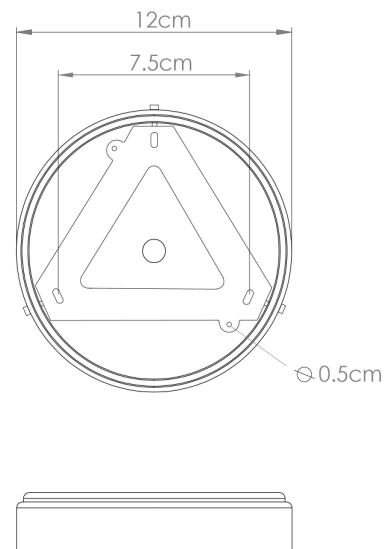

Product Notes:

1) Lamps not included with light fixture. 2) All products are individually hand crafted, therefore may differ slightly within manufacturing tolerances. 3) Please refer to: <http://www.mullanlighting.com/terms> for full list of Terms & Conditions. 4) Cable/Chain can be shortened during installation. 5) Longer Cable/Chain available on request. 6) Additional colour finishes available on request. 7.) Dimensions do not include lamps. 8.) Products wired to UL standards will operate at 110/120v with the appropriate lampholders.

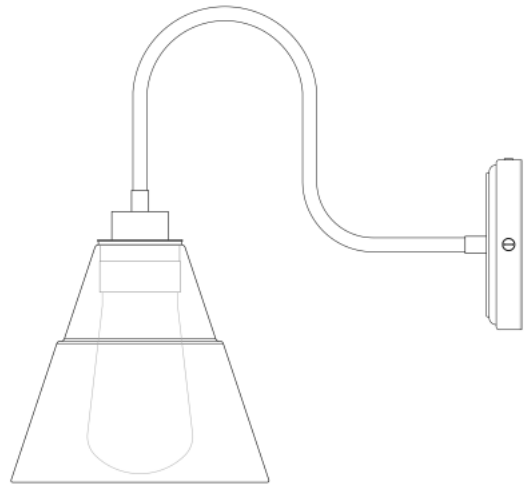

MATERIAL	Brass Glass
HEIGHT	33cm 12.99"
WIDTH DIAMETER	18cm 7.09"
LENGTH PROJECTION	36cm 14.17"
WEIGHT	1.27KG 2.8lbs
LAMPHOLDER	E27 x 1
MAX WATTAGE	6.5W x 1
VOLTAGE	220/240v
IP RATING	65
CLASS PROTECTION	II
SHADE	GL146 GLWP02
FLEX BAR CHAIN LENGT	n/a
CABLE TYPE	-

Fixing Bracket MLWB17 | Satin Brass

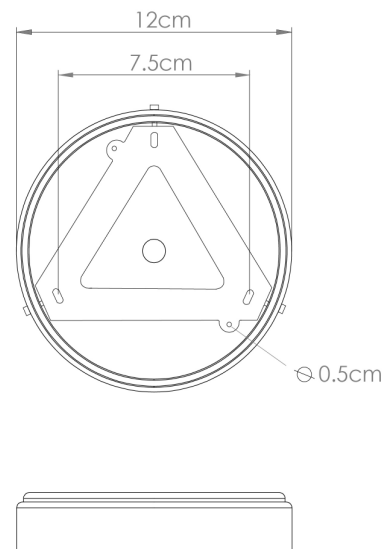

Product Notes:

1) Lamps not included with light fixture. 2) All products are individually hand crafted, therefore may differ slightly within manufacturing tolerances. 3) Please refer to: <http://www.mullanlighting.com/terms> for full list of Terms & Conditions. 4) Cable/Chain can be shortened during installation. 5) Longer Cable/Chain available on request. 6) Additional colour finishes available on request. 7.) Dimensions do not include lamps. 8.) Products wired to UL standards will operate at 110/120v with the appropriate lampholders.